

Smart choice for power™

xantrex™

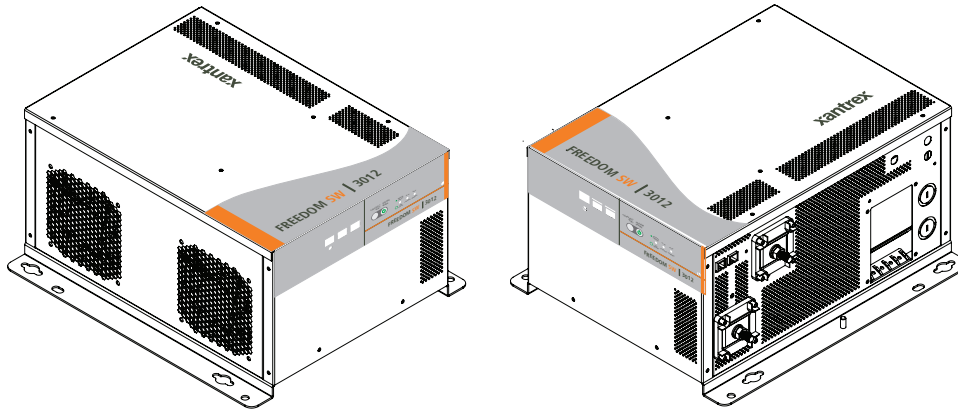

Freedom SW 3012 shown.

Owner's Guide

Freedom SW Sine Wave Inverter/Chargers

Model Numbers
815-3012, 815-3024
815-2012, 815-2024

xanbus™
E N A B L E D

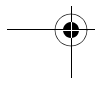
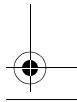
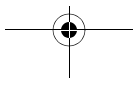
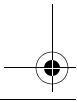
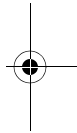
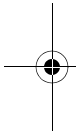
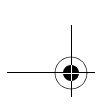

Copyright © 2013 Schneider Electric. All Rights Reserved. All trademarks are owned by Schneider Electric Industries SAS or its affiliated companies.

Exclusion for Documentation

UNLESS SPECIFICALLY AGREED TO IN WRITING, SELLER

- (A) MAKES NO WARRANTY AS TO THE ACCURACY, SUFFICIENCY OR SUITABILITY OF ANY TECHNICAL OR OTHER INFORMATION PROVIDED IN ITS MANUALS OR OTHER DOCUMENTATION;
- (B) ASSUMES NO RESPONSIBILITY OR LIABILITY FOR LOSSES, DAMAGES, COSTS OR EXPENSES, WHETHER SPECIAL, DIRECT, INDIRECT, CONSEQUENTIAL OR INCIDENTAL, WHICH MIGHT ARISE OUT OF THE USE OF SUCH INFORMATION. THE USE OF ANY SUCH INFORMATION WILL BE ENTIRELY AT THE USER'S RISK; AND
- (C) REMINDS YOU THAT IF THIS MANUAL IS IN ANY LANGUAGE OTHER THAN ENGLISH, ALTHOUGH STEPS HAVE BEEN TAKEN TO MAINTAIN THE ACCURACY OF THE TRANSLATION, THE ACCURACY CANNOT BE GUARANTEED. APPROVED CONTENT IS CONTAINED WITH THE ENGLISH LANGUAGE VERSION WHICH IS POSTED AT WWW.XANTREX.COM.

Document Part Number

97-0019-01-01

Date and Revision

September 2013 Rev D

Product Numbers

815-2012 (Freedom SW 2012), 815-2024 (Freedom SW 2024)
815-3012 (Freedom SW 3012), 815-3024 (Freedom SW 3024)

Contact Information

Telephone: 1 800 670 0707 (toll free North America)
1 408 987 6030 (direct)
Web: www.xantrex.com

Information About Your System

As soon as you open your product, record the following information and be sure to keep your proof of purchase.

Serial Number _____
Product Number _____
Purchased From _____
Purchase Date _____

To view, download, or print the latest revision, visit the website shown under Contact Information.

About This Guide

Purpose

The purpose of this Owner's Guide is to provide explanations and procedures for operating, troubleshooting, and maintaining the Freedom SW Inverter/Charger.

Scope

The Guide provides safety and operating guidelines as well as information on configuring the inverter/charger. It also provides information about troubleshooting the unit. It does not provide details about particular brands of batteries. You need to consult individual battery manufacturers for this information.

Audience

The Guide is intended for users and operators of the Freedom SW Inverter/Charger.

Conventions Used

The following conventions are used in this guide.

DANGER

STATEMENT OF HAZARD

Contains statements of avoidance or strict compliance.

Failure to follow these instructions will result in death or serious injury.

WARNING

STATEMENT OF HAZARD

Contains statements of avoidance or strict compliance.

Failure to follow these instructions can result in death or serious injury.

CAUTION

STATEMENT OF HAZARD

Contains statements of avoidance or strict compliance.

Failure to follow these instructions can result in minor or moderate injury.

NOTICE

STATEMENT OF HAZARD

Contains statements of avoidance or strict compliance.

Failure to follow these instructions can damage the unit and/or damage other equipment.

IMPORTANT: These notes describe things which are important for you to know, however, they are not as serious as a caution or warning.

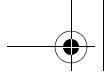

Related Information

You can find more information about Xantrex-branded products and services at www.xantrex.com.

NOTE: The Installation Guide (Document Part Number: 97-0020-01-01) is primarily intended for qualified installers who need to install and configure the Freedom SW Inverter/Charger. The installer should have knowledge and experience in installing electrical equipment, knowledge of the applicable installation codes, and awareness of the hazards involved in performing electrical work and how to reduce those hazards. A qualified technician or electrician has this knowledge and experience.

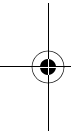

Important Safety Instructions

IMPORTANT: READ AND SAVE THIS OWNER'S GUIDE FOR FUTURE REFERENCE.

This chapter contains important safety and installation instructions for the Freedom SW Inverter/Charger (Freedom SW). Each time, before using the Freedom SW, READ ALL instructions and cautionary markings on or provided with the inverter/charger, the batteries, and all appropriate sections of this guide.

NOTE: The Freedom SW contains no user-serviceable parts.

ELECTRICAL SHOCK HAZARD

- Do not expose the Freedom SW to rain, snow, spray, or bilge water. This inverter/charger is designed for marine applications only when additional drip protection is installed in certain orientations. See the installation guide for information.
- Do not operate the inverter/charger if it has received a sharp blow, been dropped, has cracks or openings in the enclosure including if the fuse cover has been lost, damaged, or will not close, or otherwise damaged in any other way.
- Do not disassemble the inverter/charger. Internal capacitors remain charged after all power is disconnected.
- Disconnect both AC and DC power from the inverter/charger before attempting any maintenance or cleaning or working on any circuits connected to the inverter/charger. See note below.
- Do not operate the inverter/charger with damaged or substandard wiring. Make sure that all wiring is in good condition and is not undersized.

Failure to follow these instructions will result in death or serious injury.

NOTE: Turning off the inverter/charger using the on/off switch on the front panel will not reduce an electrical shock hazard.

 **DANGER**

 **DANGER**

FIRE AND BURN HAZARD

- Do not cover or obstruct the air intake vent openings and/or install in a zero-clearance compartment.
- Do not use transformerless battery chargers in conjunction with the inverter/charger due to overheating.

Failure to follow these instructions will result in death or serious injury.

 **DANGER**

EXPLOSION HAZARD

- Charge only properly rated (such as 12 V) lead-acid (GEL, AGM, Flooded, or lead-calcium) rechargeable batteries because other battery types may explode.
- Do not work in the vicinity of lead-acid batteries. Batteries generate explosive gases during normal operation. See note #1.
- Do not install and/or operate in compartments containing flammable materials or in locations that require ignition-protected equipment. See notes #2 and #3.

Failure to follow these instructions will result in death or serious injury.

NOTES:

1. Follow these instructions and those published by the battery manufacturer and the manufacturer of any equipment you intend to use in the vicinity of the battery. Review cautionary markings on these products and on the engine.
2. This inverter/charger contains components which tend to produce arcs or sparks.
3. Locations include any space containing gasoline-powered machinery, fuel tanks, as well as joints, fittings, or other connections between components of the fuel system.

Precautions When Working With Batteries

WARNING

BURN FROM HIGH SHORT-CIRCUIT CURRENT, FIRE AND EXPLOSION FROM VENTED GASES HAZARDS

- Always wear proper, non-absorbent gloves, complete eye protection, and clothing protection. Avoid touching your eyes and wiping your forehead while working near batteries. See note #4.
- Remove all personal metal items, like rings, bracelets, and watches when working with batteries. See notes #5 and #6 below.
- Never smoke or allow a spark or flame near the engine or batteries.
- Never charge a frozen battery.

Failure to follow these instructions can result in death or serious injury.

NOTES:

1. Mount and place the Freedom SW Inverter/Charger unit away from batteries in a well ventilated compartment.
2. Always have someone within range of your voice or close enough to come to your aid when you work near a lead-acid battery.
3. Always have plenty of fresh water and soap nearby in case battery acid contacts skin, clothing, or eyes.
4. If battery acid contacts skin or clothing, wash immediately with soap and water. If acid enters your eye, immediately flood it with running cold water for at least twenty minutes and get medical attention immediately.
5. Use extra caution to reduce the risk of dropping a metal tool on the battery. It could spark or short circuit the battery or other electrical parts and could cause an explosion.
6. Batteries can produce a short circuit current high enough to weld a ring or metal bracelet or the like to the battery terminal, causing a severe burn.
7. When removing a battery, always remove the negative terminal from the battery first for systems with grounded negative. If it is grounded positive, remove the positive terminal first. Make sure all loads connected to the battery and all accessories are off so you don't cause an arc.

Precautions When Preparing to Charge

WARNING

EXPOSURE TO CHEMICALS AND GASES HAZARD

- Make sure the area around the battery is well ventilated.
- Make sure the voltage of the batteries matches the output voltage of the inverter/charger.
- Be careful to keep corrosion from coming into contact with your eyes and skin when cleaning battery terminals.

Failure to follow these instructions can result in death or serious injury.

NOTES:

- Study and follow all of the battery manufacturer's specific precautions, such as removing or not removing cell caps while charging, whether equalization is acceptable for your battery, and recommended rates of charge.
- For flooded non-sealed batteries, add distilled water in each cell until battery acid reaches the level specified by the battery manufacturer. This helps to purge excessive gas from cells. Do not overfill. For a battery without removable cell caps, carefully follow manufacturer's instructions.

Regulatory

The Freedom SW Inverter/Charger is certified to appropriate US and Canadian standards. For more information see "Regulatory Approvals" on page 80.

The Freedom SW Inverter/Charger is intended to be used for mobile or commercial applications. This inverter/charger is designed for marine applications only when additional drip protection is installed in certain orientations. See the installation guide for information.

It is not intended for other applications as it may not comply with the additional safety code requirements needed for those other applications. See "Limitations On Use" below.

WARNING

LIMITATIONS ON USE

- Do not use in connection with life support systems or other medical equipment or devices.
- Do not use in ambulances or other life-saving emergency vehicles.

Failure to follow these instructions can result in death or serious injury.

FCC Information to the User

This equipment has been tested and found to comply with the limits for a Class B digital device, pursuant to part 15 of the FCC Rules. These limits are designed to provide reasonable protection against harmful interference in a residential installation. This equipment generates, uses, and can radiate radio frequency energy and, if not installed and used in accordance with the instructions, may cause harmful interference to radio communications.

However, there is no guarantee that interference will not occur in a particular installation. If this equipment does cause harmful interference to radio or television reception, which can be determined by turning the equipment off and on, the user is encouraged to try to correct the interference by one or more of the following measures:

- Reorient or relocate the receiving antenna.
- Increase the separation between the equipment and receiver.
- Connect the equipment into an outlet on a circuit different from that to which the receiver is connected.
- Consult the dealer or an experienced radio/TV technician for help.

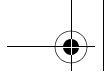

Contents

Important Safety Instructions	iv
Introduction	1
Materials List	1
Key Features	2
Key Features Explained	2
Stacking	3
Stack Charging	4
Generator Assist	4
Basic Protection Features	5
System Components	6
Xanbus System	6
Xanbus-enabled Products and Accessories	7
Freedom SW Inverter/Charger Mechanical Features	8
Freedom SW Front and Side Panels	9
Freedom Inverter/Charger Operation	11
Start Up Behavior	11
Inverter Operation Using the Front Panel	12
Operating Limits for Inverter Operation	13
Operating Limits for Charger Operation	14
Operating the Freedom SW with the SCP	15
Using the Xanbus SCP	16
System Control Panel	16

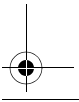
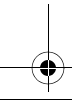
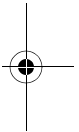
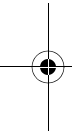

SCP Navigation	18
Startup Screen	18
Viewing the SCP Home Screens	18
Soft Key Navigation	20
Viewing the Firmware Revision Number	22
Setting the Time and Date	23
Using the STBY/ON Fault Clear Button	23
Reading the System Status Screen	24
Reading the Freedom SW Device Setup Screen	25
Configuring the Freedom SW using the SCP	28
System Menu Map	29
Viewing the System Status Screen	30
Viewing the Select Device Menu	30
Selecting the Freedom SW from the Select Device Menu	31
Changing Configurable Settings From The Device Setup Menu Screen	32
Using Search Mode	34
Equalization Procedure	36
Changing Freedom SW Basic Settings	37
Charger settings in a Dual Freedom SW configuration	40
Calculations	40
Examples	40
Changing Freedom SW Advanced Settings	41
Inverter Settings Menu	46
Using the Low Battery Cut Out and LBCO Delay Settings	47
Charger Settings Menu	48
Battery Charger Functions	49
Custom Battery Settings Menu	50

ACIn Settings	52
Gen Support	53
Stacking Configuration Menu	54
Setting the Device Name	55
Setting the Device Number	56
Resetting the Freedom SW to Default Settings	57
Using the Advanced Features	57
Battery Charging Reference	58
Battery Types	58
Charge Algorithm Stages	58
Three-Stage charging	58
Two-Stage Charging Process	61
Equalize Charging	63
Troubleshooting	65
General Troubleshooting Guidelines	65
Inverter Applications	66
Resistive Loads	66
Motor Loads	66
Problem Loads	66
Fault Types	67
Troubleshooting the Freedom SW via the SCP	68
Fault Types	68
Warning Types	69
Specifications	77

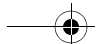
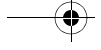

Introduction

Congratulations on your purchase of the Freedom SW Inverter/Charger (Freedom SW). The Freedom SW has been designed to give you premium power, ease of use, and outstanding reliability.

Please read this chapter to familiarize yourself with the main performance and protection features of the Freedom SW.

Materials List

The Freedom SW ships with the following items:

- one Freedom SW unit
- owner's and installation guides
- Battery Temperature Sensor (BTS)
- DC terminal covers (one red, one black) with two sets of screws
- two Xanbus network terminators
- two sets of nuts and washers for the DC terminals

NOTE: If any of the items are missing, contact customer service or any authorized Xantrex dealer for replacement. See "About This Guide" on page ii.

IMPORTANT: Keep the carton and packing material in case you need to return the Freedom SW for servicing.

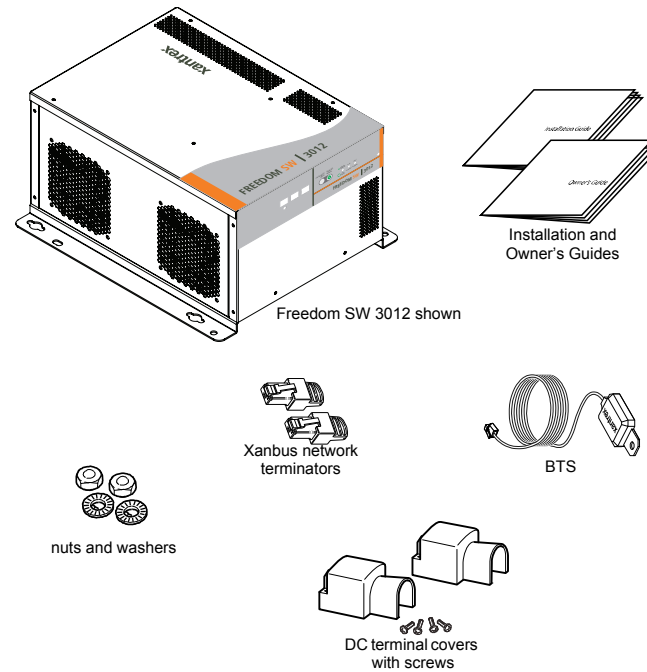

Figure 1 Materials List

Introduction

Key Features

The Freedom SW Inverter/Charger is a true sine wave inverter/charger that can be used for mobile, marine and commercial applications. The Freedom SW Inverter/Chargers are designed to operate with a wide variety of generators and are capable of operating in parallel with a generator for short durations to assist with starting large loads. The Freedom SW is a convenient combination of an inverter, multistage battery charger, and transfer switch in one electronic device.

- As an inverter, the Freedom SW provides true sine wave power for your microwave, entertainment system, computer, and other loads. This power is identical to the AC source provided from the utility grid (power company).
- Some of the benefits of true sine wave power include consistent cooking in your microwave, handling of sensitive loads such as your TV set, dimmer switches, and appliances with speed controls.
- Highly versatile platform capable of series stacking for 120/240V line configurations and parallel stacking to increase power levels.
- High efficiency true sine wave output to power sensitive electrical and electronic equipment.
- Surge capacity to start difficult loads like well pumps, refrigerators, or A/C compressors.
- Power factor-corrected (PFC) input minimizes AC input current required for charging, increasing AC pass-through capacity.
- As a charger, it has high output, multi-stage charging capability minimizing charging time.

- Capable of operating from 50Hz and 60Hz power source by extending AC qualification frequency range. See “ACIn Settings” on page 52.

IMPORTANT: Dual Line models require only the Line 1 Input to be energized in order to qualify AC. Line 2 Input does not have to be powered in a single phase system.

- Temperature-controlled, variable-speed internal cooling fans. The fans turn on when the internal temperature reaches 45 °C (113 °F) and reaches maximum speed at 70 °C (158 °F). The fan turns off when the internal temperature falls to 40 °C (104 °F).
- Designed with efficient field serviceability in mind.
- The Freedom SW Inverter/Charger is also Xanbus-enabled which allows network compatibility and communication with other Xanbus-enabled devices. See more information under “System Components” on page 6.

Key Features Explained

Built-in Charge Formulas For the unit to perform at the highest level, the batteries must be charged correctly. The Freedom SW has optimized algorithms for flooded, gel, and AGM batteries.

Battery Temperature Sensor Since battery temperature is a key factor in correct charging, the charging formula must be adjusted (automatically and in real time) according to the actual battery temperature to ensure that batteries are fully charged, but not overcharged. For this reason, a battery temperature sensor is included with your Freedom SW and has temperature compensated the charge formula.

Manual Equalization Over a period of time, the cells in a flooded battery can develop uneven chemical states. This can result in a weak (undercharged) cell which, in turn, can reduce the overall capacity of the battery. To improve the life and performance of a non-sealed, flooded battery, the Freedom SW's multi-stage charging cycle includes a manual equalize mode that can be used, if recommended by the battery manufacturer.

Dead Battery Charging Another feature that the Freedom SW includes is dead battery charging. The Freedom SW—unlike many chargers—has the ability to recharge batteries even if the battery voltage is very low, i.e., as low as 3 volts.

Load Management The Freedom SW has a built-in transfer relay that connects your inverter output or AC input from the utility grid or generator to your loads. Because the usual AC power sources such as campground outlets or small generators often have limited current availability, having the capability to manage your AC loads is extremely valuable. The Freedom SW provides a number of features to facilitate this:

- The charger is power factor corrected to use AC current as efficiently as possible. Minimizing the AC current used by the charger means more current is available for your AC loads.
- Freedom SW has a power share feature which prioritizes your AC loads by reducing the charge current and maintaining the total input current to less than the breaker setting.

Occasionally, AC input sources have low voltage. To avoid loading these weak sources any further, the charger automatically reduces its AC current draw as the AC voltage approaches the minimum acceptable level.

Stacking

Supports stacking of two inverter/chargers to increase capacity. This also requires the installer to select a Master and Slave in order for the inverters to stack. Two configurations of stacking are supported: Parallel stacking and Series stacking.

Parallel Stacking

Parallel stacking allows two inverter/chargers to operate in parallel thereby doubling the capacity in inverter mode. The two inverters communicate over the network and intelligently share the load and to balance the load between the two units. The Master Freedom SW broadcasts pulses on the Xanbus network to synchronize operation between the other paralleled unit. When AC loads are present, both units produce power, effectively sharing the load. When Search mode is enabled, only the Master unit produces the AC output.

Series Stacking

Two units can be configured to generate 120/240 Split-phase power for load configurations that require both 120 and 240 volts. In this configuration, the AC source must be split-phase as well.

Introduction

Stack Charging

Multiple Freedom SWs synchronize charging stages to ensure efficient charging of the battery bank. When a single unit transitions from bulk to absorption so do all other units. In absorption, all units must complete the absorption stage before transitioning to the next stage. Note that units do not load share when charging except during the bulk stage. The Freedom SWs stop sharing charge current just before completing the bulk stage. The units do not share charge current during the absorption and float stages.

Each unit charges batteries based on the Max Charge Rate setting and active internal (temperature-based) deratings.

If equalization is enabled on one or more devices capable of equalization charging, only those devices perform an equalize cycle after absorption. Other devices transition to float (if three-stage charging is selected) or transition to AC pass-through (if two-stage charging is selected).

Generator Assist

The Freedom SW Series of inverter/chargers can operate in tandem with a generator to temporarily assist power loads with large start-up demands such as air conditioners, water pumps etc. A Xanbus AGS must be installed in the system in order for this feature work.

When this mode is enabled and generator capacity defined, the inverter will come on-line and assist the generator when the generator reaches its capacity. The battery bank must be well charged in order for the inverter to engage this mode. For more details, see “Gen Support” on page 53.

Basic Protection Features

The Freedom SW has the following protection features:

- over temperature shutdown for critical components such as the transformer and the power board
- battery temperature sensor (BTS) failure/battery temperature out-of-range fault protection
- DC output over voltage protection during charge mode,
- AC transfer relay failure detection
- AC output overload and short circuit protection during invert mode
- AC backfeed¹ protection
- short circuit protection for the BTS and communication connector ports including protection from incorrectly inserting the remote panel communication cable plug into the BTS port and vice versa

The Battery Temperature Sensor (BTS) provides these protection features:

- battery over temperature charging protection preventing battery charging at 60 °C (140 °F) or higher
- charging voltage compensation based on the temperature of the battery the BTS is connected to

¹.An AC backfeed error occurs when the AC output of the inverter/charger is connected or routed back to the inverter/charger's AC input terminal or if the internal transfer relay fails.

System Components

The Freedom SW uses Xanbus, a network communications protocol developed to communicate the Freedom SW's settings and activity to other Xanbus-enabled devices.

You can configure and monitor the Freedom SW and every Xanbus-enabled device in the system using an optional Xanbus System Control Panel (SCP). Another component is the optional Xanbus Automatic Generator Start (AGS) which allows operation with a wide range of generators, supported through a dedicated generator input. Simply, the AGS automatically starts and stops your generator.

The Freedom Sequence Intelligent Power Manager is a fully integrated power management system that provides automatic power and load management for use in recreational vehicles (RV) while receiving power from a generator or shore power. This device works in the background to prevent monitored AC loads from exceeding shore and generator breaker capacity.

See "Xanbus-enabled Products and Accessories" on page 7 for part numbers.

Xanbus System

The Xanbus system includes the Freedom SW and other Xanbus-enabled devices. The Freedom SW is the device in a Xanbus system that typically provides network power—500 mA at 12 volts DC. All of the Xanbus-enabled devices, such as the Freedom SW, the SCP, and the AGS are able to communicate their settings and activity to each other. See Figure 1.

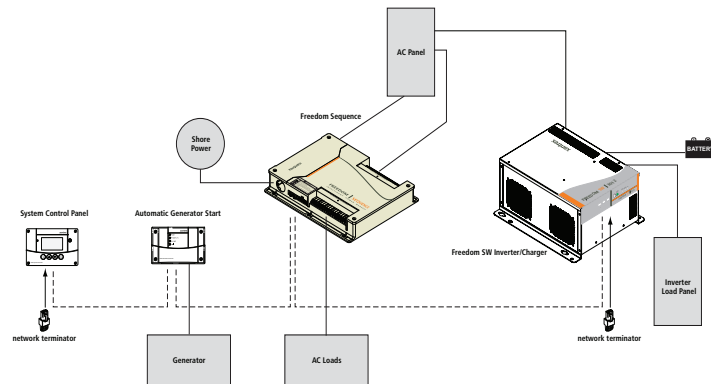

Figure 1 Typical Xanbus System Diagram

Xanbus-enabled Products and Accessories

The Xanbus-enabled designation (see below) means that this product works on a Xanbus network. Xanbus-enabled products are:

- Simple to operate and routine tasks are automated.
- Controlled by software that eliminates analog signalling errors.
- Less susceptible to interference and line loss.
- Upgradable through new software releases.

xanbus E N A B L E D

For detailed instructions and a complete list of Xanbus-enabled devices, visit www.xantrex.com.

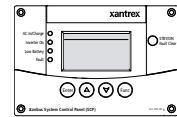

SCP

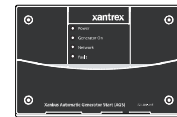

AGS

Freedom Sequence

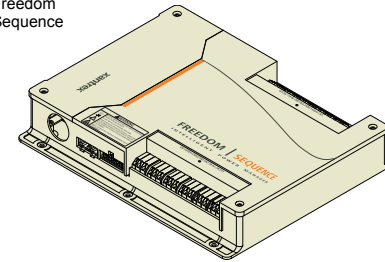

3-ft cable



25-ft cable

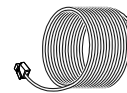

75-ft cable

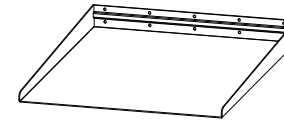

Inverter drip shield

Product/Accessory (Not Shown)	Product Number/s
Freedom SW On/Off Switch	808-9002
GFCI receptacles	808-9003
Drip shields	808-9004
Stacking cable	808-9005

Product/Accessory (Shown above)	Product Number/s
Freedom Sequence Intelligent Power Manager	809-0912 / 809-0913
Xanbus System Control Panel (SCP)	809-0921
Xanbus Automatic Generator Start (AGS)	809-0915
3-ft network cable (0.9 m)	809-0935
25-ft network cable (7.6 m)	809-0940
75-ft network cable (22.9 m)	809-0942
Inverter drip shield	808-9004

Freedom SW Inverter/Charger Mechanical Features

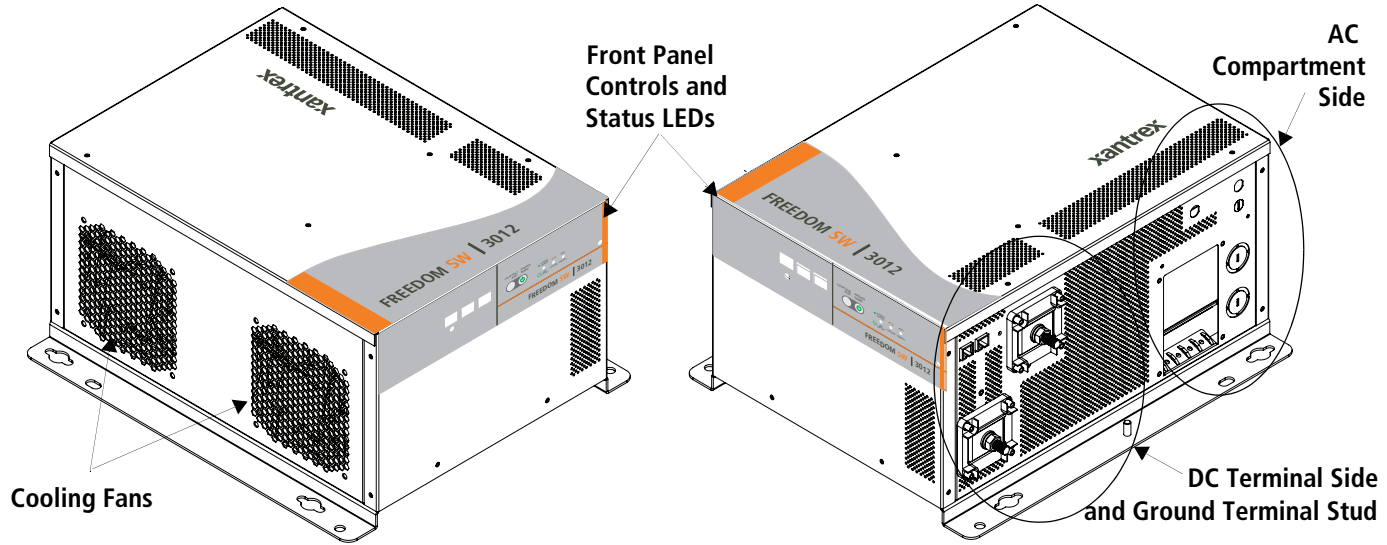

Figure 2 Freedom SW Front and Side Panels (Freedom SW 3012 shown)

Freedom SW Inverter/Charger Mechanical Features

Freedom SW Front and Side Panels

Before you begin to operate the Freedom SW, review the front panel features shown in Figure 3 and described in the next table. A detailed view of the lights and buttons on the front panel is shown in Figure 4 and described in the table next to it.

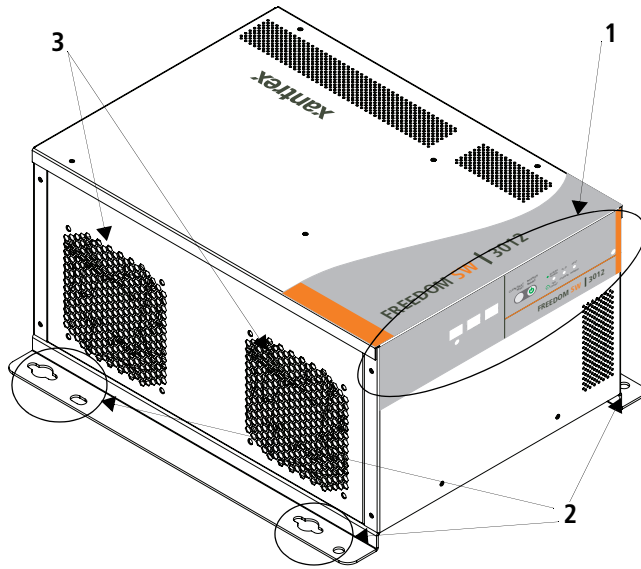
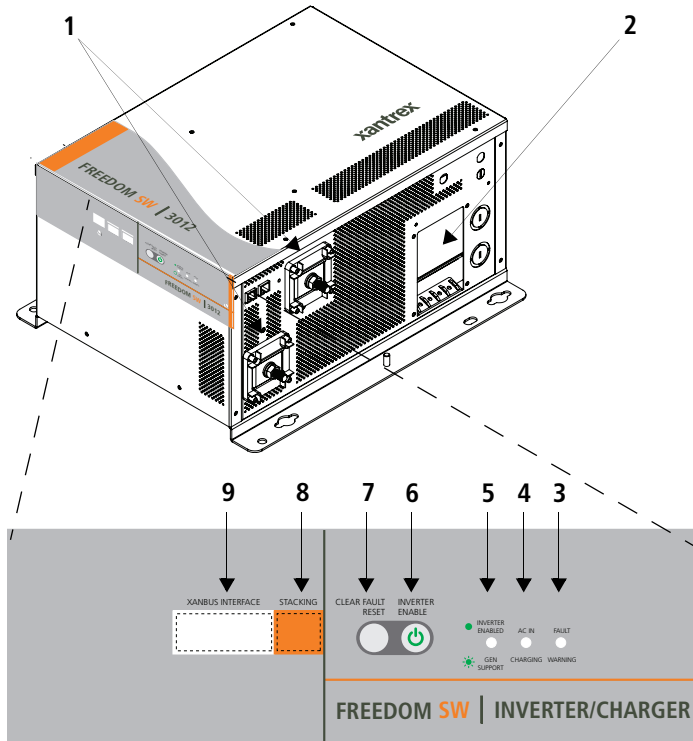

Figure 3 Isometric View of the Front Panel and Fans

Item	Description
1	Front Panel contains the Xanbus interface ports for connecting Xanbus-enabled devices, the INVERTER ENABLE and CLEAR FAULT RESET buttons, as well as various LED status lights. See Figure 4.
2	Mounting holes are used for mounting the unit. A total of eight holes are provided on the unit.
3	Two variable-speed cooling fans are used to cool the unit. Fan speed control is based on internal temperature of critical components. The two exhaust fans control airflow through the transformer and power compartments of the unit. Ensure at least six inches of clearance for proper ventilation.

Freedom SW Inverter/Charger Mechanical Features



Item	Description
1	DC terminals.
2	AC wiring compartment access panel with compartment cover on.
3	FAULT LED illuminates solid if a fault condition occurs and flashes intermittently when a WARNING condition is active.
4	When AC is present and qualified, the AC IN LED will illuminate solid indicating also that AC is passing through. CHARGING LED flashes intermittently when the Freedom SW is in charge mode and is producing DC output to charge your batteries.
5	INVERTER ENABLED indicates the invert mode is enabled. This is different from the inverter being “on”. When enabled the inverter can be on or off. When disabled, the inverter is always off. If AC is present and invert mode is enabled, this LED remains illuminated even though AC power is being passed through. GEN SUPPORT LED flashes intermittently when the inverter is in generator support mode and is assisting the generator.
6	INVERTER ENABLE button is used to enable or disable the inverter.
7	CLEAR FAULT RESET button is used to clear any active faults if pressed momentarily. If held down for more than three seconds, the unit will reset (reboot) itself.
8	STACKING port is used to connect two inverter/chargers together for stacked operation. This is required only for stacking in series.
9	XANBUS INTERFACE ports are used to connect Xanbus-enabled devices including the optional SCP and AGS.

Figure 4 Isometric View of the Front Panel and AC/DC Side Panel

Freedom Inverter/Charger Operation

Start Up Behavior

When the Freedom SW is powered up or has been reset, all of the front panel lights illuminate and remain on for a minimum of five seconds. During this interval, the fans are also turned on as the unit executes internal diagnostics.

The Freedom SW inverter is disabled every time the Freedom SW is powered up. After power up, the **INVERTER ENABLE** button (or the SCP) can be used to enable or disable the inverter.

When a function is enabled, it is allowed to occur but other conditions may have to be met before the function is activated or turned on. For example, the charger function on the Freedom SW may be enabled, but it will not charge unless qualified AC power is present.

IMPORTANT: Review the “Important Safety Instructions” on page iv before operating the inverter/charger.

Freedom Inverter/Charger Operation

Inverter Operation Using the Front Panel

IMPORTANT: Review the “Important Safety Instructions” on page iv before operating the inverter/charger.

Once the inverter/charger is installed, you can operate it in invert mode.

To operate in invert mode from the front panel:

1. Press the **INVERTER ENABLE** button on the Freedom SW on the front panel. The **INVERTER ENABLED** LED illuminates and connected loads will be energized.
2. Note that if AC is present and being passed through, the **INVERTER ENABLED** LED will still illuminate to indicate inverter mode has been enabled. However, AC will continue to be passed through to the loads until conditions exist that cause AC to be disqualified, in which case the unit will transition to invert mode and power up critical loads.
3. Connect AC input power.
The charger automatically starts up when qualified AC power is connected.

To operate the inverter with the System Control Panel, refer to “Operating the Freedom SW with the SCP” on page 15.
4. Disconnect AC power from inverter input by opening the breaker or disconnect.
5. Place a load on the inverter. For example, plug a 100-watt light bulb into an outlet that the inverter is powering. Press the **INVERTER ENABLE** button on the Freedom SW. The **INVERTER ENABLED** LED illuminates. The inverter should run the load using battery power.

6. To test the charger, reconnect the AC input power to allow AC to the AC input. The AC/Charger On LED should start flashing after a brief delay. Any AC loads previously powered by the inverter will also work at this time.

NOTE: On dual input models, only AC Input L1 needs to be powered for the unit to operate.

7. Remove the AC input power. The inverter/charger should transfer to invert mode immediately. (The transfer relay will make a clicking sound and the **INVERTER ENABLED** LED will illuminate.) Loads should continue to operate uninterrupted.

If any part of this test fails, determine the cause before using the unit.

8. Monitor the Freedom SW Front Panel.

The indicator lights on the front panel show you the operating status of the Freedom SW. A description of the lights is provided in Table 1.

If none of the front panel lights are on, see “Troubleshooting” on page 65.

Table 1 Front Panel Lights

Light Illuminated	Color	Status	Action (or Status Item)
INVERTER ENABLED	Steady Green	If utility and generator AC is unavailable and operating conditions are met, the Freedom SW will produce AC voltage to power loads.	You can run your appliances from the inverter.
GEN SUPPORT	Flashing Green	The inverter is assisting a generator in powering loads.	You can run your appliances from the inverter.

Freedom Inverter/Charger Operation

Table 1 Front Panel Lights

Light Illuminated	Color	Status	Action (or Status Item)
AC IN	Steady Green	When the Freedom SW is connected to a qualified AC source or a generator, the External AC light illuminates.	You can run your appliances from an AC source like the utility grid or a generator.
CHARGING	Flashing Green	Freedom SW is connected to a qualified AC source, is charging and passing power to AC loads.	Your battery bank is being replenished and AC loads are receiving power.
FAULT	Steady Red	A fault has occurred on the network.	Investigate and clear the fault condition.
WARNING	Flashing Red	A warning is detected.	Investigate by examining warning logs on SCP.

Faults and Warnings A fault affects the operation of the unit. A manual fault requires user intervention by clearing the condition and then pressing the **CLEAR FAULT RESET** button on the inverter/charger's front panel. See the *Xanbus System Control Panel Owner's Guide* for information on clearing faults from the SCP.

A warning alerts you to a condition that could possibly affect operation of the unit.

IMPORTANT: If you are having problems with any of your loads, refer to "Inverter Applications" on page 66.

Operating Limits for Inverter Operation

Temperature The Freedom SW series of inverter/chargers will operate at rated power continuously at 30 °C with some models capable of continuous operation at much higher ambient temperature. However, the continuous power rating at elevated ambient temperature may differ between models. See "Specifications" on page 77 for full details. In higher ambient temperatures, if the loads draw full power for an extended period of time, the unit may shut down to protect itself against overheating.

The Freedom SW series of inverter chargers feature a surge rating of 200% of rated power for five seconds at 25 °C. Operating the inverter/charger in conditions outside of power and temperature limits, however, will result in thermal shutdown and/or significantly decreased performance. In addition, operation in this range is outside the ratings covered by the regulatory approvals of the product.

Difficulty on starting loads The inverter/charger should be able to operate all AC loads rated at or below its power rating. Some high horsepower induction motors used in pumps and other motor-operated equipment require very high surge currents to start, and the inverter/charger may have difficulty starting these loads.

If you have problems starting certain loads, ensure that:

- the battery connections are tight and clean.
- the DC cabling is no longer than the recommended length. Refer to the *Freedom SW Sine Wave Inverter/Chargers Installation Guide* for this information.
- the AC wiring is of recommended size. Refer to the *Freedom SW Sine Wave Inverter/Chargers Installation Guide* for this information.
- the battery is of sufficient capacity and is fully charged.

Freedom Inverter/Charger Operation

Operating Limits for Charger Operation

By default, the maximum charger output current is the rated charger output current for the particular model. Using the SCP, you can reduce the total output if you change the maximum charge rate (**Max Chg Rate**) on the Freedom SW Basic Settings menu or Inverter Settings menu under Advanced Settings.

The charger can operate over an AC input range of 95–135 volts AC. This is the default setting and can be adjusted to 78–145 volts AC as a maximum range and to 110–120 volts AC as a minimum range. The charger can also be configured to accept and operate from a wide AC source frequency of 40 to 70 Hz. The default setting is 55 to 65 Hz. This wide range allows the Freedom SW to charge your batteries even when incoming AC voltage is less than ideal or a 50 Hz source.

Power Share The Freedom SW charger uses AC input line 1 to charge the batteries. The Freedom SW charger shares incoming power with AC loads on line 1 only. The AC loads have priority, which means that the charger will reduce its output with large AC loads and increase the output again when the AC load decreases. The regulatory maximum for continuous AC loads is 80% of the breaker rating that the loads are connected to.

The Freedom SW senses pass-through current going to the AC load. The difference between the pass-through (load) and 80% of the Power Share setting is the current that is available for charging the batteries.

For example, if the AC input of the Freedom SW is from an AC panel with a 30-amp breaker, the Power Share setting on the SCP should be selected as 30-amp. Based on this, the charger will control the charge current so that the total current draw is equal to or less than 24 amps in this case. Should the load current be more than about 24 amps, the charger output will reduce

to 0 amp, but the Freedom SW will continue to supply the loads. The Freedom SW will continue to pass-through power to the loads, even if the load current exceeds the Power Share setting. In this case, it will be up to the user to remove/disconnect loads if tripping the AC input breaker supplying the Freedom SW is to be avoided.

Operating the Freedom SW with the SCP

This section contains detailed information and procedures for using your Freedom SW in conjunction with the SCP.

If you're using the SCP to operate or monitor the status of the unit, you may also refer to the *Xanbus System Control Panel Owner's Guide*.

WARNING

LIMITATIONS ON USE

- Do not use in connection with life support systems or other medical equipment or devices.
- Do not use in ambulances or other life-saving emergency vehicles.

Failure to follow these instructions can result in death or serious injury.

The SCP provides operating, configuration, and monitoring capability for your Xanbus system.

The System Control Panel:

- Monitors activity throughout your onboard power system.
- Displays the latest information about your inverter/charger, battery voltage level, battery charge output, and generator start and stop activity.
- Displays the settings for each Xanbus-enabled device in the system.
- Enables you to adjust the settings for each Xanbus-enabled device in the system.
- Preserves all of its settings if system power is interrupted. After power is restored, you don't have to reconfigure the SCP or any of the Xanbus-enabled devices connected to it.

This section provides information on operating the Freedom SW with the System Control Panel. Please refer to the System Control Panel Owner's Guide for complete information on using the System Control Panel.

Operating the Freedom SW with the SCP

Using the Xanbus SCP

As shown in Figure 5, the SCP has these important features:

Display screen System information is shown on the display screen with an adjustable backlight.

Indicator lights Four indicator lights on the front panel indicate the operating status of the Xanbus system.

Push buttons Four push buttons allow you to select device menus and change or display settings. The red **STBY/ON Fault Clear** button toggles the SCP and Xanbus-enabled devices between Operating mode and Power Save mode, if held down for more than three seconds. The button can also be used to clear any active faults or warnings by momentarily depressing the button.

System Control Panel

The Xanbus System Control Panel (SCP) provides configuration and monitoring capability for all Xanbus-enabled devices on the network. All changes to the configuration of the Freedom SW are made with the SCP.

The front panel of the Freedom SW provides limited control, including reset; charger enable and disable; and inverter enable and disable.

Enabling a function When a function is enabled, it is allowed to occur but other conditions may have to be met before the function is activated or turned on. For example, the charger function on the Freedom SW may be enabled, but it will not charge unless qualified AC power is present.

Disabling a function When a function is disabled, it is not allowed to occur and if it is occurring, it is terminated. Regardless of other conditions, the function will not be activated. For example, even if AC power is present, if the charger is disabled, the unit will not charge.

NOTE: All functions on the front panel can also be controlled from the SCP.

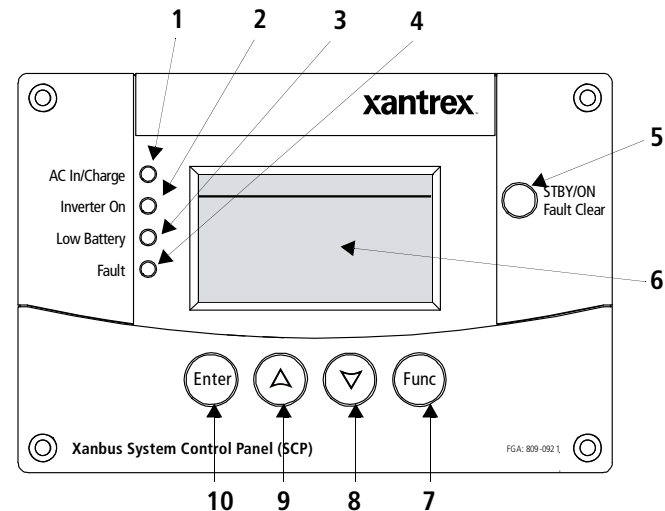

Figure 5 Xanbus System Control Panel (SCP)

Operating the Freedom SW with the SCP

Item	Description	Item	Description
1	AC In/Charge light indicates that qualified AC is present at the input of an inverter/charger. When the Freedom SW is connected to a qualified AC source like the utility grid or a generator, this light on the SCP illuminates.	7	Func button: <ul style="list-style-type: none"> • Cancels selection of a menu item. • Returns you to the previous screen. • Changes the functions of the Up and Down arrow buttons.
2	Inverter On light illuminates when the Freedom SW is inverting using battery power.	8 (and 9)	Down (and Up) arrow buttons: <ul style="list-style-type: none"> • Scrolls down (up) one line of text. • Decreases (increases) a selected value. <p>When the Func button is pressed to select:</p> <ul style="list-style-type: none"> • “Shr” - the down (and up) arrow buttons increment (decrement) shore power breaker capacity on a Freedom SW inverter/charger^a. • “AGS” - the down (and up) arrow buttons switch between different AGS Start modes (Auto, Manual-On, Manual-Off). • “Home” - the down (and up) arrow buttons enable or disable the inverter. <p>See “Soft Key Navigation” on page 20 for more information.</p>
3	Low Battery light illuminates when the battery voltage on the Freedom SW is low.	10	Enter button: <ul style="list-style-type: none"> • Confirms selection of a menu item. • Moves you to the next screen.
4	Fault light indicates a condition that requires user attention and intervention. The Fault light illuminates when any Xanbus-enabled device connected to the network is in fault. See “Fault Types” on page 67 for the definitions of a fault and warning.		
5	STBY/ON Fault Clear button is used to clear active faults on the system if pressed momentarily. It also toggles all Xanbus-enabled devices on the system between Operating and Power Save (Safe) mode when held down for more than five seconds. See “Inverter Operation Using the Front Panel” on page 12.		
6	Screen displays menus, settings, and system information. Displays a menu screen title, four lines of menu items, and a line that contains small arrows that depict pointers to SCP buttons.		

a. If the Freedom Sequence power manager is installed in the power system, the shore breaker capacity on the power manager is adjusted but not the inverter/charger.

Operating the Freedom SW with the SCP

SCP Navigation

Startup Screen

This screen is shown when the Xanbus SCP first receives power from the Xanbus network.

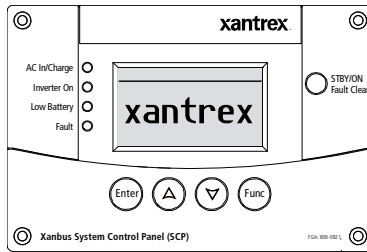
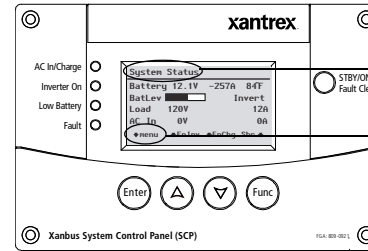

Figure 6 Startup Screen

Viewing the SCP Home Screens

The top level screens on the Xanbus SCP are the startup screen, the **System Status** screen (Figure 7) and the device **Home** screen. After power is applied and the startup screen appears, the Xanbus SCP displays the **System Status** screen. You can view the device **Home** screen for the Freedom SW and other devices in the system by pressing the up and down arrows.



Menu screen title. Every screen has one.

menu arrow that points to the **Enter** button. The menu arrow is called a soft key. See “Soft Key Navigation” on page 20 for more information.

Figure 7 System Status

System Status Screen The **System Status** screen appears after the startup screen. It displays aggregated status information for the entire power system. For example, a single system might have two Xanbus network-connected Freedom SWs, one Xanbus AGS module, and one Xanbus SCP all connected to a single battery bank.

The **System Status** screen always features a **menu** arrow pointing to the **Enter** button. Pressing **Enter** takes you to the **Select Device** menu screen. For more information, see “Reading the System Status Screen” on page 24.

IMPORTANT: If you are uncertain which Xanbus SCP menu screen you are viewing, you can return to the starting point—the **System Status** screen—by pressing the **Func** button repeatedly until the screen stops changing.

Operating the Freedom SW with the SCP

Select Device Screen As mentioned, this screen appears when the **Enter** button is pressed from the System Status screen. It lists all Xanbus-enabled devices including options to select System Settings and Clock.

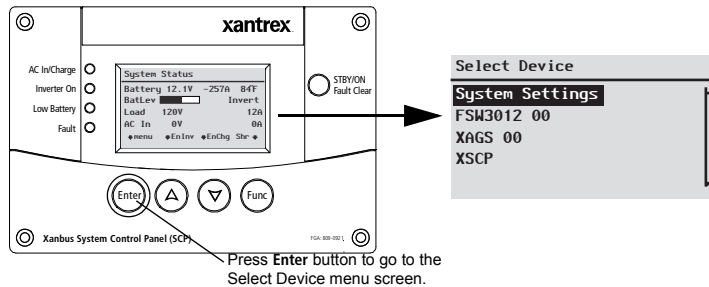

Figure 8 Freedom SW Select Device Screen

To display the Select Device menu:

- ◆ While viewing the **System Status** screen, press **Enter**.

Device Setup Screen The Device Setup screen is shown when a Xanbus-enabled component is selected from the Select Device screen. For example, below is an example of a Device screen for the Freedom SW 3012 inverter/charger. **Device Setup** menus display status information and changeable settings. Changeable settings are identified by the square brackets [] around values in the right-hand column.

To display the Setup menu for a device:

- ◆ Highlight the device name on the **Select Device** menu screen and press **Enter**.
- Or-
- From the device **Home** screen, press **Enter**.

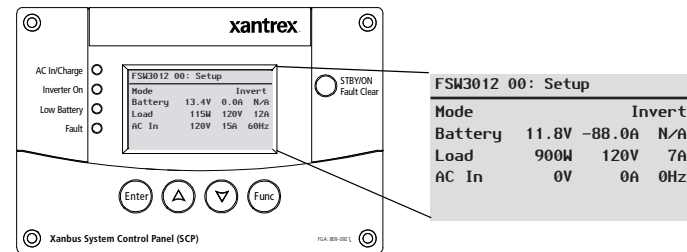

Figure 9 Freedom SW Device Screen

Operating the Freedom SW with the SCP

Soft Key Navigation

Soft keys are the objects on the fifth line of the System Status screen. The soft keys have arrows that point to a corresponding physical button such as the **Enter**, Up arrow, Down arrow, and **Func** buttons. They are called as such because they perform functions in conjunction with pressing the corresponding SCP button that each arrow points to.

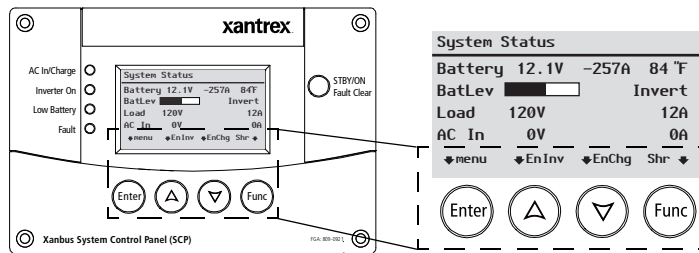

Figure 10 Soft Keys

In the next page, it will show how to navigate the soft keys to:

- activate/deactivate inverters
- activate/deactivate chargers
- change shore breaker ratings (on the inverter/charger or the Freedom Sequence power manager)
- select AGS trigger modes

Operating the Freedom SW with the SCP

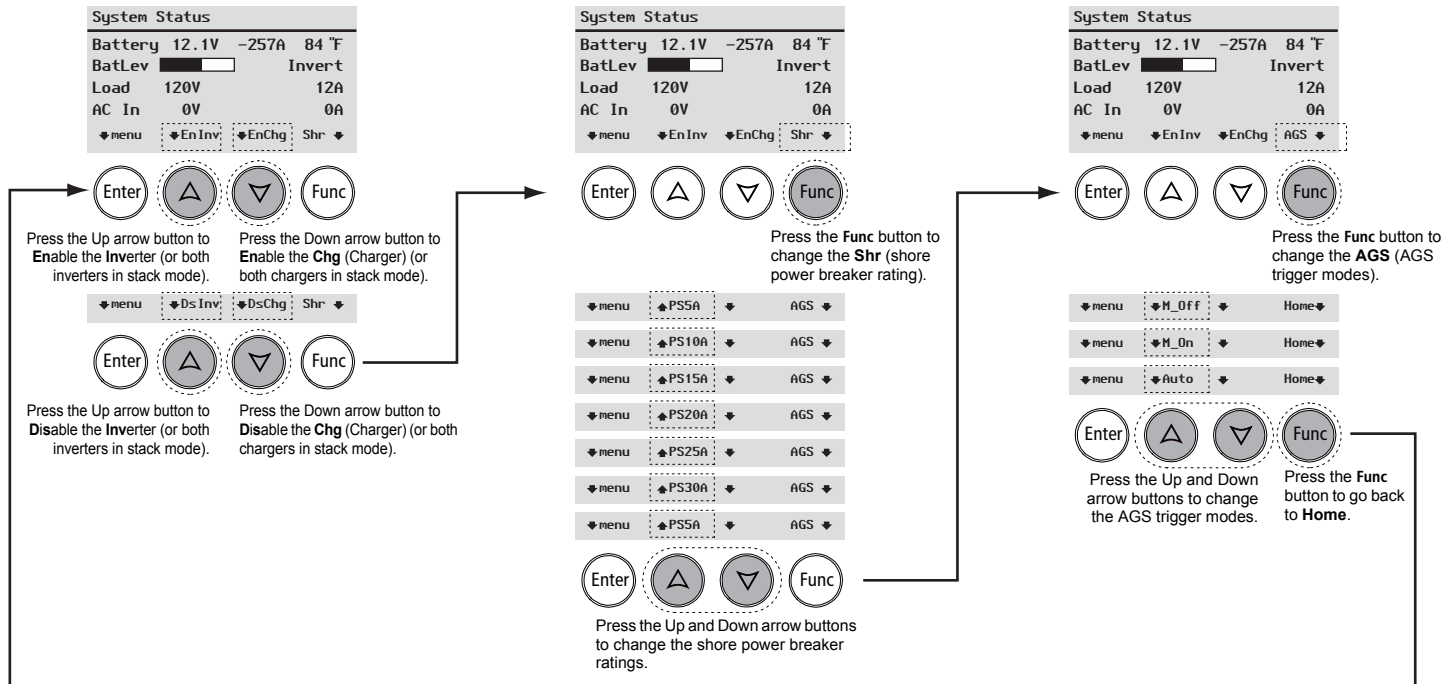

Figure 11 Freedom SW System Status Screen - Soft Key Navigation

Operating the Freedom SW with the SCP

Viewing the Firmware Revision Number

You may need to view the firmware revision number (**F/W Rev.**) of the Freedom SW when troubleshooting the unit with authorized service personnel.

To view the firmware revision number:

1. From the System Status screen, press the **Enter** button. The Select Device menu screen appears.
2. From the Select Device screen, press the **Enter** button. The System Settings menu screen appears.
3. From the System Settings screen, press the down arrow button to highlight View Device Info
4. Press **Enter**. The Device Info screen appears.
5. Read the displayed information. The series of numbers and letters opposite **F/W Rev.** is the firmware revision number.
6. Press **Func** (3x) to return to the System Settings menu.

To view the F/W Rev. from the System Status screen:

System Status

Battery	12.1V	-257A	84 °F
BatLev	<div style="width: 50%;"></div>		Invert
Load	120V		12A
AC In	0V		0A

↓menu ↓EnInv ↓EnChg Shr ↓

1 Enter ▲ ▼ Func

Select Device

System Settings

FSW3012 00
XAGS 00
XSCL

2 Enter ▲ ▼ Func

System Settings

Invert
AC Charge
System Mode
Cascading [Enabled]

3 Enter ▲ ▼ Func

System Settings

View Fault List
View Warning List
Clear All Flts/Wrns
View Device Info

4 Enter ▲ ▼ Func

Device Info

FSW3012	← Device Name
Model #	815-3012 ← Model Number
Serial #	100529833000 ← Serial Number
F/W Rev.	1.00.00 BN 107 ← Firmware Revision Number

5

6 Enter ▲ ▼ Func

Setting the Time and Date

Freedom SW advanced features such as time-stamped events (faults, warnings, and logged historical data) require that the system be set to the correct time. The Xanbus SCP has an internal clock that controls the time for all Xanbus-enabled devices in the system. You can set the time, time format, and date on the **Clock** menu. The **Clock** menu is accessible on the **Select Device** menu.

For more information, see refer to the *Xanbus SCP Owner's Guide*.

Using the STBY/ON Fault Clear Button

The **STBY/ON Fault Clear** button has two functions.

The **STBY/ON Fault Clear** is used to clear active faults on the system if pressed momentarily. It also toggles all Xanbus-enabled devices on the system between Operating and Power Save (Safe) mode when held down for more than five seconds.

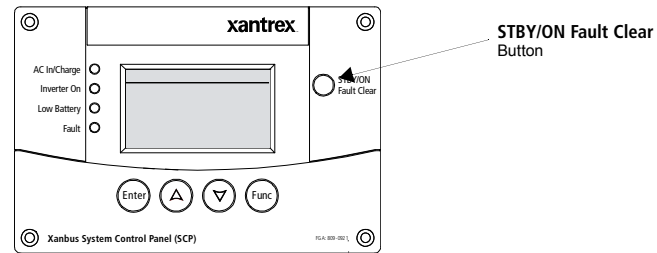

Figure 12 Xanbus SCP STBY/ON Fault Clear Button

Operating the Freedom SW with the SCP

Reading the System Status Screen

The **System Status** screen displays:

- Battery-related information (see Line 2)
- Battery level and inverter/charger operating state (see Line 3)
- Load information (see Line 4)
- AC Input information (see Line 5)

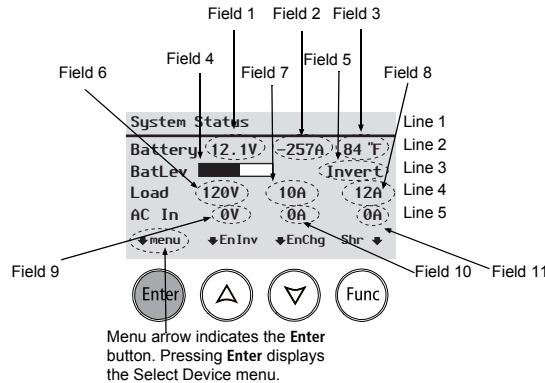

Table 2 System Status Screen

Line 1	Label: "System Settings"
Line 2	Label: Battery Field 1: Total battery current. Negative value if the battery is discharging and positive value when charging. Field 2: Battery voltage Field 3: Battery temperature ^a . Also, displays the highest temperature between stacked inverters that are installed.
Line 3	Label: BatLev Field 4: Displays a bar graph showing the approximate battery level. Field 5: Freedom SW inverter/charger operating state
Line 4	Label: Load Field 6: Inverter output voltage at load terminals of the inverter/charger. Voltage is reported by the Master unit if more than one inverter/charger is installed. Field 7: Master current ^b Field 8: Sum of all load current from both inverter and charger. Also, it displays Slave (or L2 Master) current ^d .
Line 5	Label: AC In Field 9: AC input voltage at AC In terminals of the inverter/charger. Voltage is reported by the Master unit if more than one inverter/charger is installed. Field 10: Master current ^b Field 11: Sum of all L1 AC input current ^c from both inverter and charger. Sum of all load current from both inverter and charger. Also, it displays Slave (or L2 Master) current ^d .

a. The unit of temperature can be changed in the SCP Config menu screen.

b. When in a stacked inverter configuration.

c. Only L1 AC input is taken into account. L2 AC input current is not included in the sum in Freedom SW inverter/charger models where there is L2 AC input.

d. In a single unit setup, the Slave (or L2 Master) will display 0A all the time mainly because of the absence of a second unit. If two units are stacked, the Master and Slave (or L2 Master) current will display the appropriate current values.

Operating the Freedom SW with the SCP

Reading the Freedom SW Device Setup Screen

The Freedom SW Device **Setup** menu screen displays real-time operational data (status information) specific to the Freedom SW. The Freedom SW status changes according to the states described in Table 4, “Freedom SW Device Setup Screen Operating States (Modes)” on page 27. The Freedom SW Device **Setup** menu screen has two segments. The first segment (lines 2 to 5) displays status information and appears first in the screen’s initial four lines. The second segment (lines 6 to 15) contains selectable fields when the Down arrow button is pressed (scrolling down the device setup screen). These selectable fields are configurable, meaning their values can be changed from within the setup screen or they bring up another screen (another level of configuration). For information on how to configure the Freedom SW inverter/charger, see “Configuring the Freedom SW using the SCP” on page 28.

To view the Freedom SW Setup menu screen:

1. On the **Select Device** screen, press the down arrow button until the **FSW3012 00**¹ is highlighted.
2. Then, press **Enter** to display the **FSW3012 00: Setup** screen which is the device setup menu screen.
3. Press the Up and Down arrow buttons view status information fields and move between selectable fields.

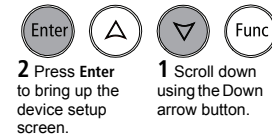
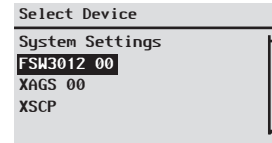

2 Press **Enter** to bring up the device setup screen.

1 Scroll down using the Down arrow button.

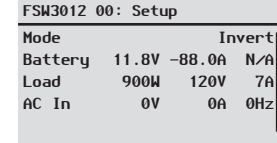

3 Press these buttons to scroll up and down the Device Setup fields.

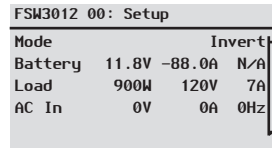

Complete list Freedom SW Device Setup fields.

Line	Field
Line 1	Mode
Line 2	Invert
Line 3	Battery 11.8V -88.0A N/A
Line 4	Load 900W 120V 7A
Line 5	AC In 0V 0A 0Hz
Line 6	Advanced Settings*
Line 7	Inverter [Enabled]
Line 8	Search Mode [Enabled]
Line 9	Charger [Enabled]
Line 10	Force Chg State
Line 11	Equalize [Disabled]
Line 12	Desired Mode [Standby]
Line 13	Clear Faults Warnings
Line 14	View Device Info
Line 15	Basic Settings

* appears only when Enter, Up, and Down arrow buttons are pressed together.

1. Typical device ID for a single installed Freedom Inverter/Charger. If there are more than one, the device name **FSW3012** is followed by **01**, **02**, et cetera.

Operating the Freedom SW with the SCP

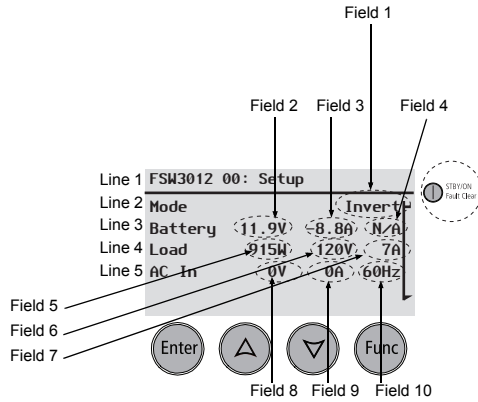

Table 3 Device Setup Screen Status Information

Line 4	<p>Label: Load Field 5: Total power drawn by AC loads connected to the unit. Field 6: Inverter output voltage at load terminals of one inverter/charger unit. Field 7: Sum of all current drawn out by the AC loads.</p>
Line 5	<p>Label: AC In Field 8: AC input voltage at AC In terminals of the inverter/charger. Field 9: Sum of all current drawn into one inverter/charger unit. Field 10: AC input frequency</p>
STBY/ON Fault Clear button	<p>Press momentarily to clear all faults on all devices on the network. Press and hold for five seconds to switch all devices in the network between operating and safe modes.</p>
Enter, Up arrow, Down arrow buttons (pressed simultaneously)	<p>Switches between Basic Settings and Advanced Settings.</p>

Table 3 Device Setup Screen Status Information

Line 1	<p>Label: "FSW3012 00: Setup"</p>
Line 2	<p>Label: Mode Field 1: Freedom SW operating mode or "operating state" (see Table 4 on page 27).</p>
Line 3	<p>Label: Battery Field 2: Total battery current. Negative value if the battery is discharging and positive value when charging. Field 3: Battery voltage Field 4: Battery temperature. Displays the highest temperature when reading multiple inverters that are installed. Displays N/A when there is no BTS attached.</p>

Operating the Freedom SW with the SCP

Table 4 Freedom SW Device Setup Screen Operating States (Modes)

State (Mode)	Displayed When...	State (Mode)	Displayed When...
Invert	The Freedom SW is supplying power to loads by inverting power from the batteries. AC input from the utility or generator is absent or out of nominal range.	Gen Support	There is AC input from the generator, and the Freedom SW is supporting the generator by supplying additional power to the critical loads. See “Gen Support” on page 53.
Qualifying AC	The Freedom SW is determining if AC input is within a usable voltage and frequency range. Qualifying AC is also displayed when the Freedom SW is awaiting application of AC power or a command to enable invert mode.	Search	Search mode is enabled and the Freedom SW is standing by, waiting to begin inverting. See “Changing Configurable Settings From The Device Setup Menu Screen” on page 32.
Charging	The Freedom SW is charging the batteries from qualified AC input from the utility grid or a generator. The charge state is in transition to either bulk, absorption, float, or equalize. AC input is also passed through to the load while charging.	Passthru	The AC connected to the AC1 or AC2 input is passing directly through the Freedom SW to the loads. The batteries are not being charged in this state.
Bulk	The Freedom SW is bulk charging the batteries from qualified AC input from the utility grid or a generator. AC input is also passed through to the load while bulk charging.	Equalize	Equalization has been turned on and the Freedom SW is equalizing the batteries after completing a full charge cycle.
Absorption	The Freedom SW is absorption charging the batteries from qualified AC input from the utility grid or a generator. AC input is also passed through to the load while absorption charging.		
ABS Finish	One Freedom SW unit has completed the absorption stage and is waiting for other Freedom SWs in the system to complete absorption. This status can occur only when there is another Freedom SW also charging the battery.		
Float	The Freedom SW is float charging the batteries from qualified AC input from the utility grid or a generator. The Freedom SW is set for three-stage charging. AC input is also passed through to the load while float charging.		
Fault	The Freedom SW has an active fault. The Fault/Warning light on the Xanbus SCP is on.		



Configuring the Freedom SW using the SCP

This section contains information about all configurable settings and procedures for the Freedom SW.

It provides information on using the SCP to configure the Freedom SW settings for optimal performance. Please refer to the *Xanbus System Control Panel Owner's Guide* for detailed information on how to use the SCP.



System Menu Map

Figure 13 provides a map of how the SCP screens and menus are organized. The order of devices appearing on the SCP will vary, depending on the order in which they've been connected to the network.

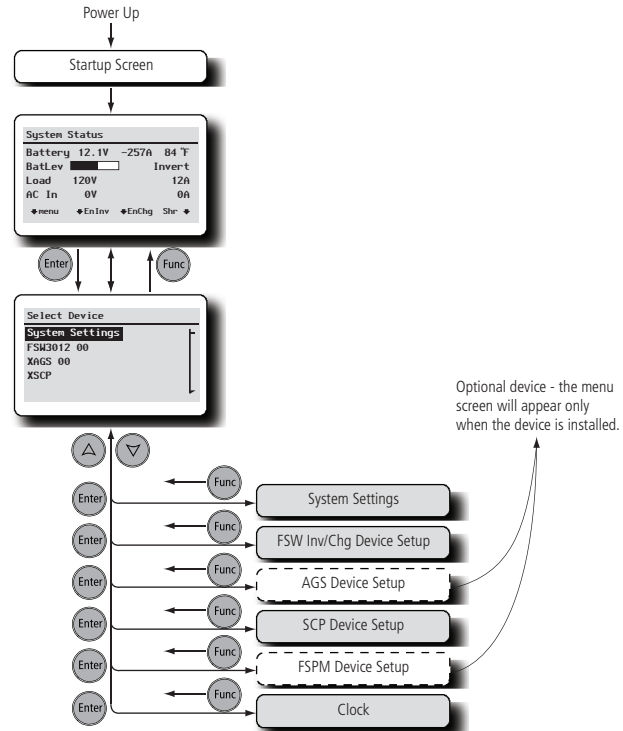

Figure 13 SCP System Menu Map

Configuring the Freedom SW using the SCP

Viewing the System Status Screen

The System Status screen displays system activity. The information appearing on the System screen varies with the status of the inverter/charger. See “Reading the System Status Screen” on page 24. Go back to “Reading the Freedom SW Device Setup Screen” on page 25 for an explanation of the different states of the inverter/charger. For example, Figure 14 shows the Freedom SW in the bulk stage of charging.

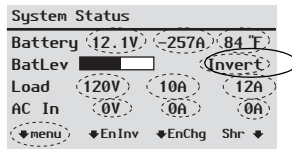

Figure 14 Bulk System Screen (Example)

You cannot select or change any of the information on the System Status screen. If you would like to view more detailed information, press the **Enter** button (indicated by the menu arrow) to go to the Select Device menu.

Viewing the Select Device Menu

The Select Device menu is where you can view a list of all the Xanbus-enabled devices in your power system.

At least two devices are sure to appear together with System Settings and Clock – the Freedom SW Inverter/Charger and the Xanbus SCP. Other devices such as the Xanbus AGS and the Freedom Sequence Intelligent Power Manager appear only when they are connected and installed.

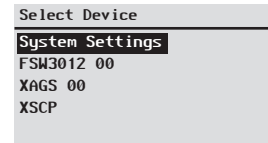
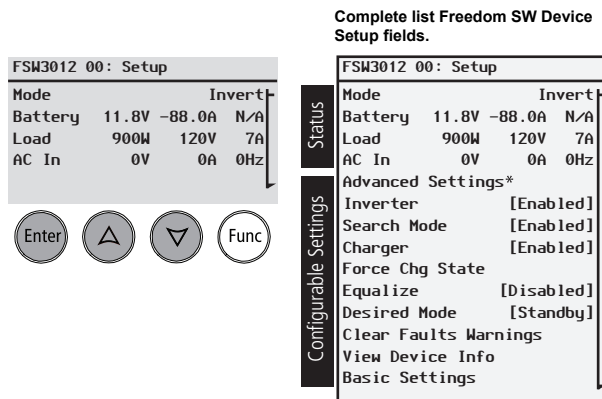

Figure 15 Select Device Screen

Selecting the Freedom SW from the Select Device Menu

To view the Freedom SW Setup menu screen:

- ◆ Follow the procedures on page 25.



* appears only when Enter, Up, and Down arrow buttons are pressed together.

Figure 16 Device Setup Menu Screen

You can view and change Freedom SW settings from the Setup menu screen. The **Basic Settings** and **Advanced Settings** bring up their menu screens for which other configurable settings can be found.

Configuring the Freedom SW using the SCP

Changing Configurable Settings From The Device Setup Menu Screen

The Freedom SW can only be configured using the Xanbus SCP. Follow the procedure in “To view the Freedom SW **Setup** menu screen:” on page 25 to bring up the device setup screen for the Freedom SW inverter/charger.

These configurable settings are:

- Advanced settings
- Inverter
- Search mode
- Charger
- Force charge
- Equalize
- Desired mode
- Clear fault settings
- View device info
- Basic settings

FSW3012 00: Setup		Line 1
Status	Mode	Invert
	Battery	11.8V -88.0A N/A
	Load	915W 120V 7A
	AC In	0V 0A 0Hz
	Advanced Settings*	
Configurable Settings	Inverter	[Enabled]
	Search Mode	[Disabled]
	Charger	[Disabled]
	Force Chg State	
	Equalize	[Disabled]
	Desired Mode	[Standby]
	Clear Faults Warnings	
	View Device Info	
	Basic Settings	

NOTE: The Xanbus SCP only displays four lines of the device Setup menu at once. To view configurable settings, press the Down arrow button.

* appears only when Enter, Up, and Down arrow buttons are pressed together.

Figure 17 Freedom SW Device Setup Menu

As discussed in “Reading the Freedom SW Device Setup Screen” on page 25 the Freedom SW Device Setup menu screen has two segments. The first segment (lines 2 to 5) displays status information and appears first in the screen’s initial four lines. The second segment (lines 6 to 15) contains selectable fields which are configurable settings.

Only nine of these settings are displayed at a time. The **Advanced Settings** (Line 6) is not initially listed and only lines 7 through 15 appear. When the Advanced Settings is listed, it will appear on top of the list for configurable settings and the setup screen will display lines 6 through 14. See Table 5, “Configurable Settings” on page 34 for information on each setting.

Configuring the Freedom SW using the SCP

To select and change a configurable setting:

1. On the setup menu, press the down arrow (or up arrow) button to highlight the setting you want to change.
2. Press **Enter** to highlight the current value of the setting.
3. Press the up arrow or the down arrow button to change the value. Hold down the button to scroll through a large range of values quickly.
The previously set value (or default value) appears with an asterisk (*) beside it.
4. Press **Enter** to select and confirm the value.
5. If you have another setting to change, return to step 1.

-Or-

If you have no more settings to change, press **Func** until the Xanbus SCP displays the desired screen or menu.

IMPORTANT: If you have no more settings to change, it is recommended to leave the **Setup** menu in the basic settings format to help prevent unintended configuration. If the **Setup** menu displays **Advanced Settings**, press **Enter** + up arrow + down arrow at the same time. The Setup menu should then display **Basic Settings** as the last item on the menu.

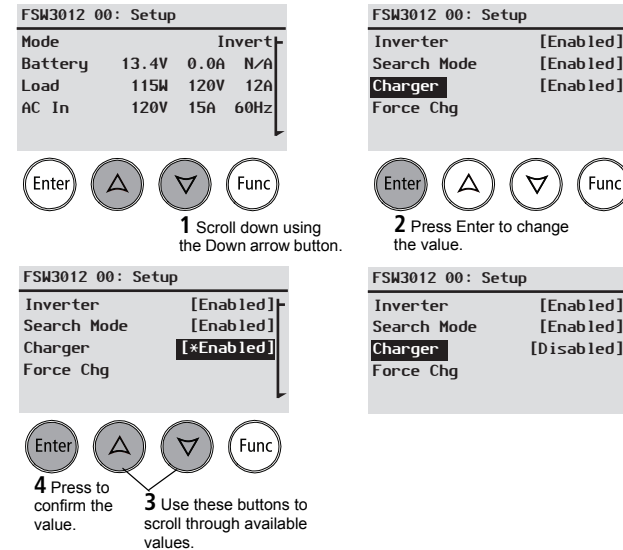

Figure 18 Selecting and Changing a Configurable Setting

Configuring the Freedom SW using the SCP

Table 5 Configurable Settings

Item	Description
Inverter	Enables or disables the inverter function of the Freedom SW. When enabled, the unit will invert power from the batteries assuming there is enough charge in the batteries. Default value is Enabled.
Search Mode	Enables or disables the Search Mode function of the Freedom SW. See “Using Search Mode” on page 34 for more information. Default value is Disabled.
Charger	Enables or disables the charger function of the Freedom SW. When enabled, the unit will charge the batteries when AC is available. For more information on configuring the charger settings go to “Charger Settings Menu” on page 48. Default value is Enabled.
Auto Chg Enable	Forces the Freedom SW to charge the batteries when qualified input AC is detected even when the charger function is disabled.
Equalize	Initiates the battery equalization process. See “Equalization Procedure” on page 36 to enable the procedure. Default value is Disabled.
Desired Mode	Switches between Operating and Standby modes. Default value is Operating.
Clear Faults Warning	Clears any active faults and warnings.
Basic Settings	See “Changing Freedom SW Basic Settings” on page 37 for more information.
Advanced Settings	See “Charger settings in a Dual Freedom SW configuration ” on page 40 for more information.

Follow procedures on “To select and change a configurable setting:” on page 33 to change the settings.

Using Search Mode

Why use Search mode? Search mode allows the inverter to selectively power only items that draw more than a certain amount of power, which can result in power savings. The Freedom SW has a no-load power draw of about 28 watts. Enabling search mode reduces this power draw to less than 8 watts. Search mode operates differently in single-unit and multi-unit installations.

Single units When a single Freedom SW has search mode enabled, the inverter sends electrical search pulses through its AC output. These search pulses look for connected AC loads. The delay between search pulses is set using the **Search Delay** setting. After a load larger than the **Search Watts** setting is detected, the inverter starts producing AC output.

Multiple units When configured for 120/240-volt series stacking, each inverter/charger operates independently in search mode and attempts to detect loads connected to its terminals only.

To use search mode in parallel stacking, the Master unit must have **Search Mode** disabled. The Slave unit must have **Search Mode** enabled.

IMPORTANT: The Slave unit continuously monitors the output of the Master unit. If the Master unit has more than 60% of the rated load (e.g., 1800 watts on Freedom SW 3012), the Slave unit will assist the Master and the two will share the load equally. Should the load on the Master drop below 20% of rated load (600 watts for Freedom SW 3012), the Slave unit disengages and returns to a waiting state.

Configuring the Freedom SW using the SCP

When to set up Search mode The search mode feature is only valuable if the inverter can spend a fair amount of time “sleeping” each day. Therefore, if search mode is to be used it must be adjusted properly. The initial adjustment should be made so that the inverter comes on only when needed.

Certain types of loads can cause search mode to work unexpectedly. These types of loads are described “Inverter Applications” on page 66. If these kinds of loads are in the system, follow the suggestions given to eliminate the problem.

If the problem loads cannot be eliminated, there are two work-around solutions:

1. Disable search mode from the main Freedom SW Setup menu, causing the inverter to always remain at full output voltage.
2. Use a search-friendly companion load whose only purpose is to be switched on to wake up the inverter to power the load that is unable to bring the inverter out of search mode.

NOTES:

- Search mode, by function, cannot work with clocks and timers or devices that need power 24 hours a day. Examples of devices with timers include video recorders, coffee makers with brew timers, refrigerators, and freezers with defrost timers. Examples of devices that need power 24 hours a day include telephone answering machines, alarm systems, motion detection lights, and some thermostats.
- When the inverter is searching the output for loads, lights that have a wattage lower than this setting may flash momentarily.

Configuring the Freedom SW using the SCP

Equalization Procedure

To start equalizing the batteries, do one of the following:

- Apply AC voltage and ensure that the inverter/charger transfers AC and starts charging.
- On the Xanbus Setup menu, highlight **Equalize** and select **Enable**. The unit will proceed and execute a complete bulk and absorption charge before transitioning to equalize.

IMPORTANT: The inverter/charger will not perform equalization if AC is not present, the charger is disabled, or the selected battery type does not support equalization. If any of these cases happen, a warning is issued

If the Freedom SW will not perform the equalization, see “Warning Types and Behavior” on page 69.

IMPORTANT: In a system where more than one device is capable of equalizing batteries (such as multiple Freedom SWs), there is no system-wide equalization command for all devices. To equalize with multiple devices, each would have to be enabled individually. Alternatively, equalization can be performed using only one device. During the equalization process, one device applies the equalization charge while the other devices continue to operate in synchronized charge mode, typically in float (three-stage charging) or no-float (two-stage charging).

WARNING

EXPLOSION HAZARD

Only flooded or vented batteries should be equalize charged. Hydrogen and oxygen gases are produced when batteries are equalize charged. Provide adequate ventilation and remove all sources of ignition to prevent explosion.

Failure to follow these instructions can result in death or serious injury.

Changing Freedom SW Basic Settings

Basic Settings menu The Freedom SW configuration settings can be viewed in basic format (see “Selecting Basic Settings From the Device Setup Screen” on page 37). The basic settings include configuration items you may have to adjust routinely, or as part of initial setup. It provides access to basic control of the inverter/charger.

To select the Basic Settings menu screen:

1. On the **FSW3012 00: Setup** screen (Figure 19), press the down arrow button until **Basic Settings** is highlighted.

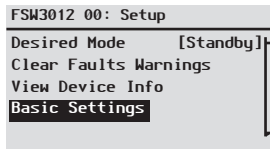

Figure 19 Selecting Basic Settings From the Device Setup Screen

2. Then, press **Enter** to display the **FSW3012 00: Basic** screen which is the basic settings menu screen.
3. Press the Up and Down arrow buttons to move between selectable fields.

The Freedom SW basic settings include menus for configuring:

- Battery type
- Battery capacity
- Maximum charging rate
- Charging cycle
- Recharging volts
- AC In breaker rating
- Low battery cutout value

See Table 7, “Basic Settings” on page 39 for information on each setting.

Configuring the Freedom SW using the SCP

An overview of the Freedom SW menu structure is shown below. The SCP displays the Freedom SW basic settings menu.

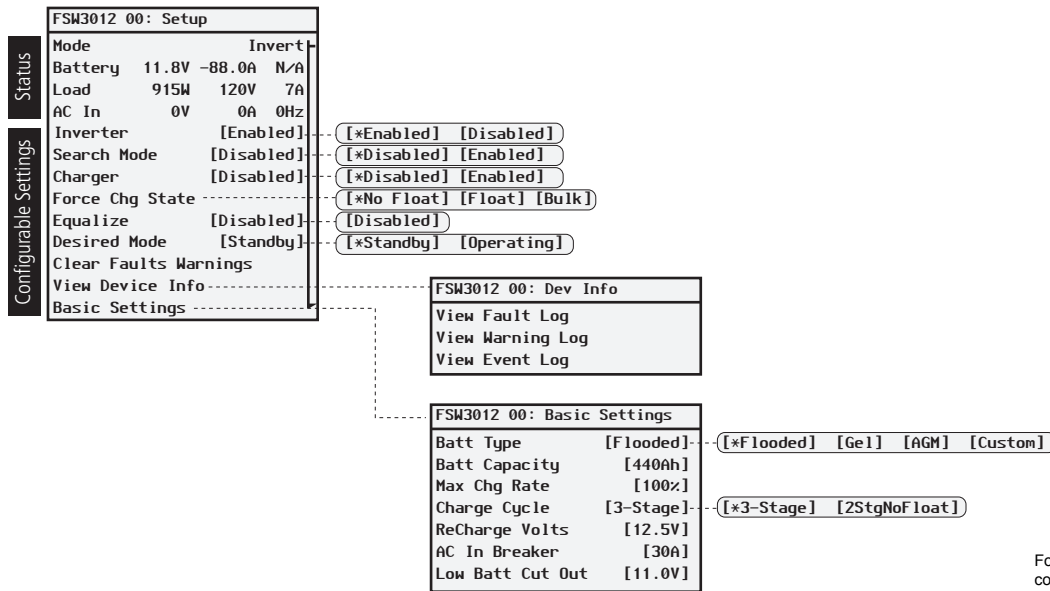

Follow procedures on "To select and change a configurable setting:" on page 33 to change the settings.

Figure 20 Menu Map of the Freedom SW Basic Settings

Configuring the Freedom SW using the SCP

Table 6 Setting Defaults and Ranges

Model	Freedom SW 2012 / 3012			Freedom SW 2024 / 3024		
Item	Default	Min	Max	Default	Min	Max
Batt Type	Flooded	Flooded, Gel, AGM, Custom		Flooded	Flooded, Gel, AGM, Custom	
Batt Capacity 2000-watt models	250Ah	50Ah	2000Ah	250Ah	50Ah	1000Ah
Batt Capacity 3000-watt models	440Ah			440Ah		
Max Chg Rate	100%	10%	100%	100%	10%	100%
Charge Cycle	3Stage	3Stage, 2StgNoFloat		3Stage	3Stage, 2StgNoFloat	
ReCharge Volts	12.5V	11.0V	13.5V	25.0V	22.0V	27.0V
AC1 Breaker	30A	5A	30A	30A	5A	30A
Low Batt Cut Out	10.5V	10.0V	12.0V	21.0V	20.0V	24.0V

Table 7 Basic Settings

Item	Description
Batt Type	Sets the system battery chemistry and type: Flooded , AGM , Gel , and Custom . Selecting Custom displays the Custom Settings item, which allows you to adjust the settings for each charging stage.
Batt Capacity	Selects the system battery capacity in amp hours. Setting the battery capacity to 0 resets the charging current to its default values. Zero Ah battery capacity implies there is no absorption exit current criteria and absorption only exits when the absorption timer (default 3hrs, range 1min-8hr) expires.
Max Chg Rate	Sets the percentage of the maximum DC output current that is available to the charger. The maximum DC output current for different models is: <ul style="list-style-type: none"> Freedom SW 2012 —100 ADC Freedom SW 3012 —150 ADC Freedom SW 2024 —50 ADC Freedom SW 3024 —75 ADC If multiple Freedom SWs are charging the same battery bank, set each inverter's Max Chg Rate to 1/n of the desired charge rate (where n is the number of inverter/chargers).
Charge Cycle	Sets the charging method: 3-Stage (bulk, absorption, float) or 2StgNoFloat (bulk, absorption, no float).
ReCharge Volts	Sets the recharging volts to tell the charger to initiate charging when the battery drains past the value setting.
AC In Breaker	Set the breaker limit of incoming AC.
Low Batt Cut Out	Low Battery Cut Out (LBCO) controls when the inverter stops producing AC output due to a low battery voltage condition. The inverter will stop producing AC output only after this level has been reached for the period of time set by the LBCO Delay . This setting is not temperature compensated.

Configuring the Freedom SW using the SCP

Charger settings in a Dual Freedom SW configuration

The Freedom SW2012 includes a 100 A charger. When using two stacked Freedom SW2012 inverter/chargers connected to the **same battery bank**, a total of 200 A of bulk charging is possible into that single common battery bank. For small battery banks and/or certain battery types this bulk mode current may be too high, therefore Freedom SW models include the “**Battery Bank Capacity**” and “**Max Charge Rate**” settings.

“**Battery Bank Capacity**” is the bank’s total Amp-hour capacity, this is best determined by a qualified RV electrical technician, while the “**Max Charge Rate**” is determined by the battery manufacturer/type of battery model being used, i.e. Flooded, Gel, AGM being the most popular. For “Flooded” type battery bank, the *preferred* charger capacity (A)/battery bank capacity (Ah) is usually 10-15%C (C = Battery Bank Amp-hour capacity), however the *max* charge rate allowable is often accepted as 25% C, while some AGM or Gel battery models are higher (50% C or, in rare cases, up to 100% C). Do not exceed battery manufacturers recommended max charge specifications as resultant battery temperature rise will shorten battery life.

Calculations

Once installed and configured, each Freedom SW charger calculates its own actual bulk charge current limit as follows:

(User selectable “Max Charge Rate” %) x (User selectable Battery Bank Ah capacity) = Actual maximum charger #1 **output Amps** in bulk mode (note: Limited to the Charger’s maximum capacity) then,

(Charger #1 Actual **output Amps**) + (Charger #2 Actual **output Amps**) = “System Total BULK output” **Amps** (for the stacked pair).

This “Total bulk output current” flows into the battery bank. As this total bulk current is split/distributed within the bank thru each individual parallel and/or series connected battery, the current each battery “sees” **must not exceed each individual battery’s max allowed charge current** as specified by the battery manufacturer. Since most battery banks are/should be constructed of the same battery type, model and length of interconnecting cables, current sharing is roughly equal through each parallel branch of battery(ies), therefore the above generalizations of “Max Charge Rate %” can be made for the entire bank.

The Freedom SW’s “Max Charge Rate(%)” setting is set to “100%” by default, but is adjustable 0-100%, therefore if the charger has max possible 100 A (as in the FSW2012), when set to Max Chg Rate of 100% FSW2012 is capable of delivering its full 100 A into the battery bank. However if this is too high, the installer/operator may reduce this % setting to suit the system battery type and bank requirements/limitations, to avoid overheating the battery bank. The user/installer is responsible for configuring the charger to ensure the **battery manufacturer’s recommended max charge rate Amps** is not exceeded for longest battery life and best performance.

Examples

Example 1: In a system composed of two stacked FSW2012’s, industry commonly accepted practice suggests a typical Flooded battery bank of capacity (C) 400 Amp-hours should not be charged at a rate in excess of 25% of “C”. i.e. 25% x 400(Ah) = 100 Amps. Therefore, when configuring the two stacked Freedom SW chargers, each charger must be limited to contributing max 50 A into the common battery bank. This is accomplished

Configuring the Freedom SW using the SCP

by setting each charger's "Max Charge Rate"% setting to deliver ½ of the desired total battery bank charge rate **of 100 A**, i.e. In this example, each charger "Max Charge Rate" should be set to at most "50%" therefore $50\% \times (\text{charger max capacity of } 100 \text{ A}) = 50 \text{ Amps}$ actual max output, therefore since we have two chargers $50 \text{ A} + 50 \text{ A} = 100 \text{ A}$ which is the max bulk current this battery bank can accept.

Example 2: The Freedom SW3012 includes a 150 A charger, when using two stacked Freedom SW3012 inverter/chargers connected to the same battery bank, a total of 300 A of bulk charging is possible.

In a system composed of two stacked FSW3012's. Industry commonly accepted practice suggests, a typical Flooded battery bank of capacity (C) 400Amp-hours should not be charged at a rate in excess of 25% of "C" i.e. $25\% \times 400(\text{Ah}) = 100 \text{ Amps}$. Therefore, when configuring the two stacked Freedom SW chargers, each charger must be limited to contributing max 50 A each into the common battery bank. This is accomplished by setting each charger's "Max Charge Rate"% setting to deliver ½ of the desired total battery bank charge rate **of 100 A**. i.e. in this example, each charger "Max Charge Rate" should be set to "33%" x **(charger max capacity of 150 A)** = 50 A actual max output, therefore $50 \text{ A} + 50 \text{ A} = 100 \text{ A}$ which is the max bulk current this battery bank can accept.

Example 3: The Freedom SW 3012 includes a 150 A charger, when using two stacked Freedom SW3012 inverter/chargers connected to the same battery bank, a total of 300 A of bulk charging is possible.

In the above system composed of two stacked FSW3012's. Industry commonly accepted practice suggests, a typical Flooded battery bank of capacity (C) 1000 Amp-hours should not be charged at a rate in excess of 25% of "C" i.e. $25\% \times 1000(\text{Ah}) = 250 \text{ Amps}$. Therefore, when configuring

the two stacked Freedom SW chargers, each charger must be limited to contributing max 125 A each into the common battery bank. This is accomplished by setting each charger's "Max Charge Rate"% setting to deliver ½ of the desired total battery bank charge rate **of 250 A**, i.e. in this example, each charger "Max Charge Rate" should be set to "83%" x **(charger max capacity of 150 A)** = 125 A actual max output, therefore $125 \text{ A} + 125 \text{ A} = 250 \text{ A}$ which is the max bulk current this battery bank can accept.

Example 4: The Freedom SW 3024 includes a 75 A(@24 V) charger, when using two stacked Freedom SW3024 inverter/chargers connected to the same battery bank, a total of 150 A(@24 V) of bulk charging is possible. Industry commonly accepted practice suggests, a typical Flooded battery bank of capacity (C) 600 Amp-hours (@ 24 V) should not be charged at a rate in excess of 25% of "C" i.e. $25\% \times 600(\text{Ah}) = 150 \text{ Amps} (@24 \text{ V})$. Therefore, when configuring the two stacked Freedom SW chargers, each charger must be limited to contributing max 75 A (@24 V) into the common battery bank. This is accomplished by setting each charger's "Max Charge Rate"% setting to deliver ½ of the desired total battery bank charge rate of **150 A**. i.e. in this example, each charger "Max Charge Rate" should be set to "100%" x **(75 A charger max capacity)** = 75 A actual max output, therefore $75 \text{ A} + 75 \text{ A} = 150 \text{ A}$ which is the max bulk current this battery bank can accept.

Changing Freedom SW Advanced Settings

Advanced Settings menu The advanced settings option gives you access to the full range of Freedom SW settings, including everything displayed on the basic menu. As a safeguard against unintended advanced configuration,

Configuring the Freedom SW using the SCP

the Xanbus SCP displays the basic settings by default. To view the advanced settings, you must perform a special keypress (see “Selecting Advanced Settings From the Device Setup Screen” on page 43).

NOTE:

This keypress enables the advanced settings for every device in the system. After performing the keypress, **Advanced Settings** appears in the list and **Basic Settings** disappears.

CAUTION

FIRE AND ELECTRICAL SHOCK HAZARD

The advanced settings are intended for qualified installation/service personnel only. Before changing advanced settings, you must be familiar with the settings and the system-wide impact of changing those settings. Setting parameters incorrectly could damage connected equipment (such as batteries) or could severely affect the performance of your system. Incorrect charging configuration can lead to battery damage and risk of fire.

Failure to follow these instructions can result in minor or moderate injury.

The Freedom SW advanced settings include menus for configuring:

- Inverter settings (see page 46).
 - Charger settings (see page 48).
 - AC transfer limit settings (see page 52).
 - Generator support settings (see page 53).
- Stacking operation, including customizing the default model name of the Freedom SW, and setting its network device number. Setting the device number is important when multiple Freedom SWs are on the Xanbus network and sharing connections such as AC loads, utility grid, and generator. The device number is also used when configuring paralleled Freedom SWs for Master-Slave operation (see page 54).
 - Restoring default settings (see page 57) and other advanced features (see page 57).

Freedom SW advanced menu screen lists status information and settings which require that you understand and plan for the changes you make. You may not have to adjust these settings as part of regular operation.

The SCP shows the Freedom SW basic menu by default. To view the advanced settings menu, you have to activate it by following the procedure below.

To select the Advanced Settings menu screen:

1. On the **FSW3012 00:Setup** screen (Figure 21), press the **Enter**, Up arrow, Down arrow buttons simultaneously to make Advanced Settings appear in the list.
2. On the **FSW3012 00:Setup** screen, press the down arrow button until **Advanced Settings** is highlighted.

Configuring the Freedom SW using the SCP

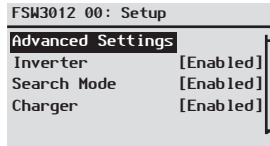

Figure 21 Selecting Advanced Settings From the Device Setup Screen

3. Then, press **Enter** to display the **FSU3012 00: Adv** screen which is the advanced settings menu screen.
4. Press the Up and Down arrow buttons to move between selectable fields.

IMPORTANT: The Basic Settings and Advanced Settings menu screens do not appear at the same time. You have to perform the preceding procedure to switch between having Basic Settings or Advanced Settings appear on the device setup screen.

Configuring the Freedom SW using the SCP

An overview of the Freedom SW advanced settings menu structure is shown below and the next page.

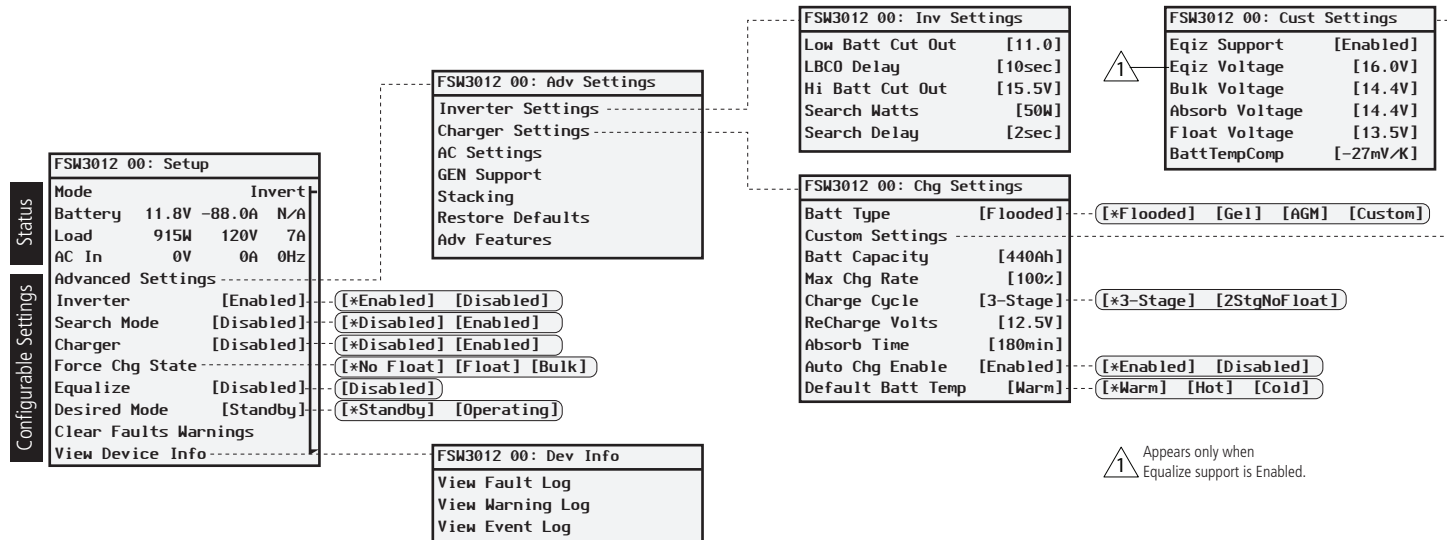

Figure 22 Menu Map of the Freedom SW Advanced Settings 1

Configuring the Freedom SW using the SCP

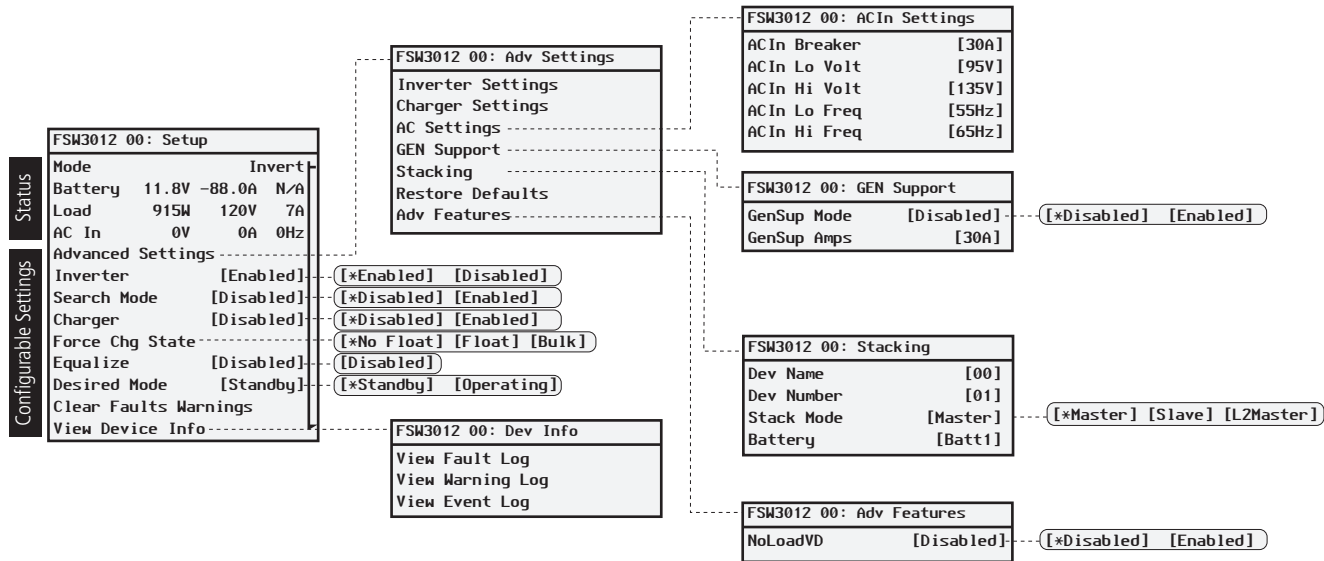

Figure 23 Menu Map of the Freedom SW Advanced Settings 2

Configuring the Freedom SW using the SCP

Inverter Settings Menu

The **Inverter Settings** menu contains settings that control when the Freedom SW starts and stops producing AC output.

FSW3012 00: Inv Settings	
Low Batt Cut Out	[11.0]
LBCO Delay	[10sec]
Hi Batt Cut Out	[15.5V]
Search Watts	[50W]
Search Delay	[2sec]

Follow procedures on "To select and change a configurable setting:" on page 33 to change the settings.

Figure 24 Inverter Settings Menu Screen

Table 8 Setting Defaults and Ranges

Model	Freedom SW 2012 / 3012			Freedom SW 2024 / 3024		
	Default	Min	Max	Default	Min	Max
Low Batt Cut Out	10.5V	10.0V	12.0V	21.0V	20.0V	24.0V
LBCO Delay	10sec	0sec	600sec	10sec	0sec	600sec
Hi Batt Cut Out	16.5V	14.5V	17.0V	33.0V	29.0V	15.5V
Search Watts	50W	25W	250W	50W	25W	250W
Search Delay	2sec	1sec	25sec	2sec	1sec	25sec

Table 9 Inverter Settings Description

Item	Description
Low Batt Cut Out	Low Battery Cut Out (LBCO) controls when the inverter stops producing AC output due to a low battery voltage condition. The inverter will stop producing AC output only after this level has been reached for the period of time set by the LBCO Delay . This setting is not temperature compensated.
LBCO Delay	LBCO Delay controls how long the inverter is allowed to operate at or below the Low Batt Cut Out level before turning off due to a low battery voltage condition. The inverter will stop producing AC output only after the Low Batt Cut Out level has been reached for this uninterrupted period of time. Once the inverter has shut off, the battery voltage must rise 2 volts above the Low Batt Cut Out setting (4 volts for 24-volt systems) for inverter operation to resume.
Hi Batt Cut Out	Hi Batt Cut Out sets the maximum battery voltage at which the inverter will operate. If the battery voltage exceeds this limit for more than one minute, the Freedom SW displays a fault message and shuts down. The inverter will not support AC loads when in this condition. If a qualified AC source is present, the unit passes AC through to the loads. The inverter automatically restarts when the voltage drops to 1.5 volts (12 volt system) or 3 volts (24 volt system) below the Hi Batt Cut Out setting. If battery voltage continues to rise after shutdown, an external charger may still be charging the batteries. The Freedom SW cannot control how external chargers operate.
Search Watts	Search Watts sets the Freedom SW's search sensitivity when search mode is enabled. When a load larger than this setting is present, the inverter starts producing AC output. Enabling search mode from the Setup menu (see page 57) can minimize power draw from the battery during periods of low demand from loads. Also see "Using Search Mode" on page 34.

Configuring the Freedom SW using the SCP

Table 9 Inverter Settings Description

Item	Description
Search Delay	Search Delay sets the time between search pulses. When searching for loads, the Freedom SW sends out search pulses to determine if a load is present. If the Freedom SW finds a load above the Search Watts setting, the inverter turns on. Freedom SW power draw while in search mode decreases when Search Delay is increased, but the Freedom SW's response time to active loads is slower.

LBCO Delay Settings

The **Low Batt Cut Out** setting is the lowest battery voltage level acceptable for use by the inverter. When the batteries discharge to the **Low Batt Cut Out** setting, and are held at or below this level for the **LBCO Delay** time, the inverter output shuts down and transfers any available AC source (generator or grid) to the charger to bring the battery level back above the **Low Batt Cut Out** setting. After shutdown, the inverter does not support any AC loads, and AC loads must be powered by either a generator or utility power.

- If using an automatic generator starting system, it is recommended to set the Xanbus AGS voltage trigger setting higher than the Freedom SW **Low Batt Cut Out** voltage.
- Although not recommended, if using an automatic generator starting system with the start trigger set to the same voltage as the **LBCO** voltage, do not set the **LBCO Delay** to less than the amount of time it takes the generator to start and connect.

Otherwise – in both of the scenarios above – inverter output turns off before the generator automatically starts, causing the battery voltage to recover slightly. This may then stop the Xanbus AGS from starting the generator or result in the Freedom SW cycling on and off multiple times before the generator automatically starts.

Using the Low Battery Cut Out and

Configuring the Freedom SW using the SCP

Charger Settings Menu

The **Charger Settings** menu provides options for configuring the Freedom SW to operate from your battery bank.

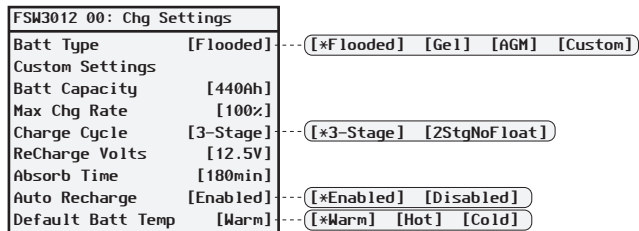

Follow procedures on "To select and change a configurable setting:" on page 33 to change the settings.

Figure 25 **Charger Settings** Menu Screen

Table 10 Setting Defaults and Ranges

Model	Freedom SW 2012 / 3012			Freedom SW 2024 / 3024		
	Default	Min	Max	Default	Min	Max
Batt Type	Flooded	Flooded, Gel, AGM, Custom		Flooded	Flooded, Gel, AGM, Custom	
Batt Capacity 2000-watt models	250Ah	50Ah	2000Ah	250Ah	50Ah	2000Ah
Batt Capacity 3000-watt models	440Ah			440Ah		
Max Chg Rate	100%	10%	100%	100%	10%	100%
Charge Cycle	3Stage	3Stage, 2StgNoFloat		3Stage	3Stage, 2StgNoFloat	
ReCharge Volts	12.5V	11.0V	13.5V	25.0V	22.0V	27.0V
Absorb Time	180min	1min	480min	180min	1min	480min
Auto ReCharge	Enabled	Enabled, Disabled		Enabled	Enabled, Disabled	
Default Batt Temp	Warm	Hot, Warm, Cold		Warm	Hot, Warm, Cold	

Configuring the Freedom SW using the SCP

Table 11 Charger Settings Menu Description

Item	Description
Batt Type	Sets the system battery chemistry and type: Flooded , AGM , Ge1 , and Custom . Selecting Custom displays the Custom Settings item, which allows you to adjust the settings for each charging stage.
Custom Settings	Displays the Custom Battery Settings menu, where you can adjust settings specific to your battery type and installation. It is only displayed if Custom is selected as the Batt Type .
Batt Capacity	Selects the system battery capacity in amp hours. Setting the battery capacity to 0 resets the charging current to its default values. Zero Ah battery capacity implies there is no absorption exit current criteria and absorption only exits when the absorption timer (default 3hrs, range 1min-8hr) expires.
Max Chg Rate	Sets the percentage of the maximum DC output current that is available to the charger. The maximum DC output current for different models is: <ul style="list-style-type: none"> Freedom SW 2012 —100 ADC Freedom SW 3012 —150 ADC Freedom SW 2024 —50 ADC Freedom SW 3024 —75 ADC If multiple Freedom SWs are charging the same battery bank, set each inverter's Max Chg Rate to 1/n of the desired charge rate (where n is the number of inverter/chargers).
Charge Cycle	Sets the charging method: 3Stage (bulk, absorption, float) or 2StgNoF loat (bulk, absorption, no float).
ReCharge Volts	Sets the recharging volts to tell the charger to initiate charging when the battery drains past the value setting.
Auto ReCharge	Enables or disables automatic charging. When there are two or more power sources for charging batteries, Auto ReCharge can be disabled to allow manual charging of batteries.

Table 11 Charger Settings Menu Description

Item	Description
Absorb Time	Sets the maximum time spent in the absorption stage, before transitioning to float or no float. NOTE: The Absorb Time setting resets to its default value of 180 minutes when the Battery Type is changed except when changing to Custom Settings. In Custom Settings, the Absorb Time setting will not reset to its default value.
Default Batt Temp	Selects the battery temperature charging compensation if a battery temperature sensor is not installed. In the absence of a battery temperature sensor, the charger uses one of three settings: Co ld (5 °C/41 °F), Warm (25 °C/77 °F), or Hot (40 °C/104 °F).

Battery Charger Functions

When AC power is available, the Freedom SW can operate as a battery charger. Different battery types and chemistries require different charging voltage levels. Not charging batteries at the required levels can shorten battery life or damage the batteries. The Freedom SW is configured at the factory to work with the battery types recommended for inverter applications. If the default settings do not work for your specific installation, you can adjust the charge stage settings (as recommended by the battery manufacturer) on the **Custom (Battery) Settings** menu (see page 50).

NOTE: This information is provided for guidance only. Variations in battery chemistry and site-specific environmental considerations mean that you should consult your system designer or battery manufacturer for specific recommendations for appropriate battery voltage and current settings.

Configuring the Freedom SW using the SCP

Custom Battery Settings Menu

NOTICE

EQUIPMENT DAMAGE

To avoid damaging your batteries during charging or equalization, consult your battery manufacturer and associated documentation before setting a custom battery type.

Failure to follow these instructions can damage the unit and/or damage other equipment.

FSW3012 00: Cust Settings

Eqiz Support	[Enabled]
Eqiz Voltage	[16.0V]
Bulk Voltage	[14.4V]
Absorb Voltage	[14.4V]
Float Voltage	[13.5V]
BattTempComp	[-27mV/K]

Appears only when Equalize support is Enabled.

Follow procedures on "To select and change a configurable setting;" on page 33 to change the settings.

Figure 26 Custom Settings Menu Screen

Table 12 Setting Defaults and Ranges

Model	Freedom SW 2012 / 3012			Freedom SW 2024 / 3024		
Item	Default	Min	Max	Default	Min	Max
Eqiz Support	Enabled	Enabled, Disabled		Enabled	Enabled, Disabled	
Eqiz Voltage	15.5V	13.5V	16.0V	31.0V	27.0V	32.0V
Bulk Voltage	14.4V	12.0V	16.0V	28.8V	24.0V	32.0V
Absorb Voltage	14.4V	12.0V	16.0V	28.8V	24.0V	32.0V
Float Voltage	13.5V	11.0V	16.0V	27.0V	22.0V	32.0V
Batt Temp Comp	27-mV	0-mV	45-mV	54-mV	0-mV	90-mV

The **Custom Battery Settings** menu can be viewed if **Custom** is selected as the **Batt Type**. This menu allows you to adjust charging and equalization voltage for batteries with specifications that fall outside the default settings for the battery types the Freedom SW offers. You can also adjust the temperature compensation constant for the battery temperature sensor on this menu.

IMPORTANT: All settings for configuring a custom battery type are based on the default settings for a flooded battery type.

Table 13 on page 51 describes the items on the **Custom Battery Settings** menu.

Table 13 Custom Battery Settings Menu Description

Item	Description
Eq1z Support	Enables or disables the ability to enter an equalization cycle. Refer to the battery manufacturer's specifications to determine whether equalization is recommended.
Eq1z Voltage^a	Selects the equalization voltage. Consult your battery manufacturer for equalization voltage setting.
Bulk Voltage	Sets the bulk voltage for a custom battery type. See note below.
Absorb Voltage	Sets the absorption voltage for a custom battery type.
Float Voltage	Sets the float voltage for a custom battery type. See note below.
Batt Temp Comp	Battery temperature compensation for a custom battery type. This setting is the reference that the BTS uses to adjust the charging voltage when the temperature is above or below 25 °C (77 °F).

a. The **Eq1z Voltage** setting is displayed when **Eq1z Support** is set to **0n**.

NOTE: If a warning is received indicating that a setting is not accepted by the SCP, gradually increase the value of the setting until the SCP accepts it. This type of warning means that an internal minimum threshold value is being crossed and therefore the setting cannot be saved.

Configuring the Freedom SW using the SCP

ACIn Settings

The **ACIn Settings** menu configures the voltage and frequency limits for AC Input quantification range. These are the limits at which the Freedom SW considers input voltage qualified—that is, suitable for charging batteries or powering loads. If the input voltage is not qualified according to these settings, the Freedom SW transfers from using AC input to inverting.

FSW3012 00: ACIn Settings	
ACIn Breaker	[30A]
ACIn Lo Volt	[95V]
ACIn Hi Volt	[135V]
ACIn Lo Freq	[55Hz]
ACIn Hi Freq	[65Hz]

Follow procedures on "To select and change a configurable setting:" on page 33 to change the settings.

Figure 27 ACIn Settings Menu Screen

Table 14 Setting Defaults and Ranges

Model	Freedom SW 2012 / 3012			Freedom SW 2024 / 3024		
	Default	Min	Max	Default	Min	Max
AC1 Breaker	30A	5A	30A	30A	5A	30A
AC1 Lo Volt	95V	78V	115V	95V	78V	115V
AC1 Hi Volt	135V	125V	140V	135V	125V	140V
AC1 Lo Freq	55V	44V	59V	55V	44V	59V
AC1 Hi Freq	65V	61V	70V	65V	61V	70V

Table 15 ACIn Settings Menu Description

Item	Description
AC1 Breaker	Sets the AC1 (Grid) breaker size, based on the size of the breaker installed on AC1. The installed breaker size must not exceed the capacity of the upstream distribution panel. The Freedom SW limits the maximum input current to this setting by derating its charging current to an equivalent of 80% of the AC breaker size. If the connected loads exceed the AC1 breaker setting, the AC breaker trips. The breaker may not trip if grid support is enabled and battery voltage is above the Grid Supp Volts setting, or if peak load shave is enabled and the load shave time window is active.
AC1 Lo Volt	Minimum acceptable input voltage level from the utility mains. NOTE: It is recommended to leave this setting to its default value and not to set it to the maximum allowed. Doing so might inadvertently derate charging power in jurisdictions where the nominal AC mains voltage or generator output is at 110 volts.
AC1 Hi Volt	Maximum acceptable input voltage level from the utility mains.
AC1 Lo Freq	Minimum acceptable utility mains input frequency.
AC1 Hi Freq	Maximum acceptable utility mains input frequency.

Gen Support

GEN Support allows power to be automatically drawn from the batteries to assist an AC generator to support heavy loads (i.e., loads that exceed the available current from the generator).

Generators have a limited output current and it is possible to reach this limit when operating heavy loads. The Freedom SW is designed to assist the generator when heavy current demands load down the generator by supplying additional power from the batteries.

In addition, the battery charger can reduce its charging current to the batteries so the combined charge AC current and total load current does not exceed the capacity of the generator or trip its output breakers or fuses.

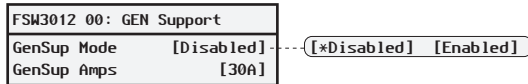

Follow procedures on "To select and change a configurable setting:" on page 33 to change the settings.

Figure 28 GEN Support Menu Screen

NOTE: Running and start-up (peak) currents are limited to the maximum current limits of the inverter.

Table 16 GEN Support Menu Description and Values^a

Setting	Description	Default	Range
GenSup Mode	Turns the generator support feature on and off.	Disabled	Disabled, Enabled
GenSup Amps	Sets the generator load level at which the Freedom SW supplies power from the batteries to support the generator.	24A	4A to 24A

a. Applies to all Freedom SW models.

The Freedom SW supports the generator (or other power source) when the AC load current drawn from the generator exceeds the **GenSup Amps** setting for one to two seconds.

The system can enter this state if the battery voltage is above **Low Battery CutOut (LBCO)** plus 1 volt and generator support is enabled.

Configuring the Freedom SW using the SCP

Stacking Configuration Menu

The **Stacking** menu configures the Freedom SW to operate as a part of a multi-unit installation.

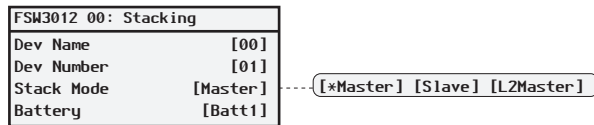

Follow procedures on "To select and change a configurable setting:" on page 33 to change the settings.

Figure 29 Stacking Menu Screen

IMPORTANT: Accessing this menu automatically places the Freedom SW in standby mode. When entering the **Stacking** menu, the unit identifies itself by flashing all front panel lights. After exiting the **Stacking** menu, the Freedom SW returns to operating mode and the front panel lights stop flashing.

Table 17 Stacking Menu Description and Values^a

Item	Description	Default	Range
Dev Name	Allows the customizing of the default name for the inverter/charger. This setting is optional and does not affect operation. See "Setting the Device Name" on page 55.	FSW3012 in the case of Freedom SW 3012.	Can be changed by the user.
Dev Number	Allows setting of a unique unit number in a multiple-unit system. See "Setting the Device Number" on page 56.	00	00–31
Stack Mode	<p>Series Stacking: For this to operate, one Freedom SW must be configured to Master and the other as L2Master, otherwise a system-wide fault is asserted.</p> <p>Parallel Stacking: For this to operate, one Freedom SW must be configured to Master and the other as Slave, otherwise a system-wide fault is asserted.</p>	Master	Master, Slave, L2Master
Battery	Points the system to which battery bank is used.	Batt1	Batt1–Batt5

a. Applies to all Freedom SW models.

When installing a stacked system, every setting on the **Stacking** menu (except for **Dev Name**) must be configured for each Freedom SW in the system. The settings should be configured in the following order:

- Dev Number
- Stack Mode

Setting the Device Name

The **Dev Name** setting allows you to customize the name of the Freedom SW as it is displayed on other screens and menus.

Changing the device name is not mandatory for stacking to be successful. It simply allows a user to distinguish between multiple inverter/chargers that are installed in the same system.

The characters available are:

- A to Z
- a to z
- 0 to 9
- space

NOTE: Increasing the number of characters in a device name may cause other text on the same line to run off the edge of the screen. Device names should be limited to 10 characters or less.

Some examples of names are: “Master”, “Slave”, “Main”, and “Secondary”.

To customize the Freedom SW name:

1. On the device setup menu, select **Advanced Settings**.
If **Basic Settings** appears instead of **Advanced Settings** on the device setup menu, display **Advanced Settings** by pressing **Enter** + Up arrow + Down arrow at the same time.
2. Select the **Stacking** menu.
3. Select **Dev Name**.
4. Press **Enter**.
The last letter of the Freedom SW name is highlighted.
5. Begin customizing the device name.
 - To change the character, press the up or down arrow button. Holding down the button causes the characters to scroll more quickly.
 - To delete the character, press **Func**.
 - To add characters, press **Enter**.
6. When the correct character is shown, press **Enter** to select it.
7. After pressing **Enter** to select the last character of your customized device name, press **Enter** again to return to the menu.

Configuring the Freedom SW using the SCP

Setting the Device Number

Setting the device number gives a Xanbus-enabled device a unique identity when several devices of the same type are installed in the power system network. When each identical device has a unique number, the Xanbus SCP can correctly identify and display status information for each device. A device number consists of two digits ranging from 00 (default) to 31.

If only one of each type of device is installed in the network, you do not need to set the device number. However, setting the device number to a value other than 00 is recommended in case you need to use the **Restore Defaults** command (which resets the device number to 00). After performing the command, checking that the device number has returned to 00 indicates that the command was successfully completed.

To set the Freedom SW device number:

1. On the Freedom SW Setup menu, select **Advanced Settings**.
If **Basic Settings** appears instead of **Advanced Settings** on the **Setup** menu, display **Advanced Settings** by pressing **Enter** + Up arrow + Down arrow simultaneously.
On the **Advanced Settings** menu, select **Stacking** and press **Enter**.
2. On the **Stacking** menu, select **Dev Number**.
3. Press **Enter** to highlight the instance number.
4. Use the up and down arrow buttons to adjust the two-digit identifier number.
5. Press **Enter**.

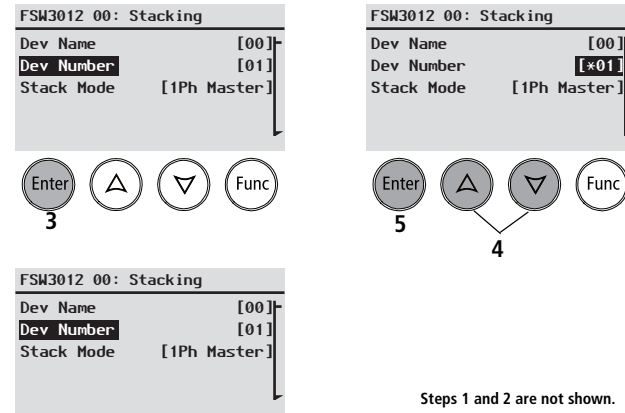

Figure 30 Setting a Device Number

Resetting the Freedom SW to Default Settings

The **Restore Defaults** command returns the Freedom SW to factory default settings. After using the **Restore Defaults** command, the Freedom SW is no longer configured for the power system.

To restore Freedom SW default settings:

1. On the **Advanced Setup** menu, select **Restore Defaults**.
Warning W252 appears, asking to confirm the command.
2. To cancel the command, press **Func**. To continue with the **Restore Defaults** command, press **Enter**.

IMPORTANT: If a warning is already active in the system, selecting **Restore Defaults** brings up the **Warnings** list, with warning W252 at the top. Press **Enter** to view W252 and continue with the restore defaults process.

NOTICE

EQUIPMENT DAMAGE

Do not restore defaults while the Freedom SW is operating. De-energize the power system and disconnect the Freedom SW AC input before restoring defaults. Reconfigure the Freedom SW before reconnecting the AC input and re-energizing the power system.

Failure to follow these instructions can damage the unit and/or damage other equipment.

Using the Advanced Features

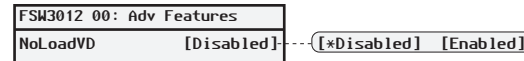

Follow procedures on "To select and change a configurable setting:" on page 33 to change the settings.

Figure 31 Adv Features Menu Screen

Table 18 Adv Features Description and Values^a

Item	Description	Default	Range
NoLoadVD	When enabled, power save mode can reduce tare loss from the battery by reducing output from 120 volts to 110 volts when the loads are less than 100 watts. When the Freedom SW detects loads higher than 100 watts, it produces the full 120 volts.	Disabled	Disabled, Enabled

a. Applies to all Freedom SW models.

Battery Charging Reference

This section describes the multistage charging algorithm (formula) of the Freedom SW.

Battery Types

Freedom SW charges flooded (or wet) lead-acid, Gel, AGM (absorbed glass mat), and custom batteries.

- **Flooded (or wet)** batteries have removable battery caps for refilling with distilled water and testing the electrolyte.
- **Gel** batteries have the electrolyte in the form of a gel rather than a liquid and do not require topping up. Gel batteries are sealed and the battery caps are not removable.
- **AGM (Absorbed Glass Mat)** batteries are similar to gel batteries except that the electrolyte is absorbed into a fiberglass matting.
- **Custom** battery is configured by the dealer, factory, or service center for battery types other than those listed above.

NOTICE

RISK OF BATTERY DAMAGE

Since the Freedom SW can only select one battery type setting for all batteries connected to its bank, *do not mix* battery types. All connected batteries should either be: Flooded (or wet) *or* Gel *or* AGM *or* Custom.

Failure to follow these instructions can damage the unit and/or damage other equipment.

Charge Algorithm Stages

Three-Stage charging

If three-stage charging is enabled, the Freedom SW will charge batteries in a sequence known as three-stage charging. Whenever qualified AC power is present at the inverter's input, it passes power through to the connected load and begins charging the batteries. The charging voltage delivered to the battery depends on the battery's:

- type setting
- temperature (by switch setting or battery temperature sensor)
- state of charge

The three automatic stages are:

- bulk
- absorption
- float

See Figure 32 for a graph of the three-stage charging profile.

There is a fourth stage, equalization, which is initialized manually as it is only performed occasionally and only on flooded (or wet) batteries.

Battery Charging Reference

The charging cycle is a multi-stage (three-stage) process. Whenever qualified AC power is present at the inverter's input, it passes power through to the connected load and begins charging the batteries.

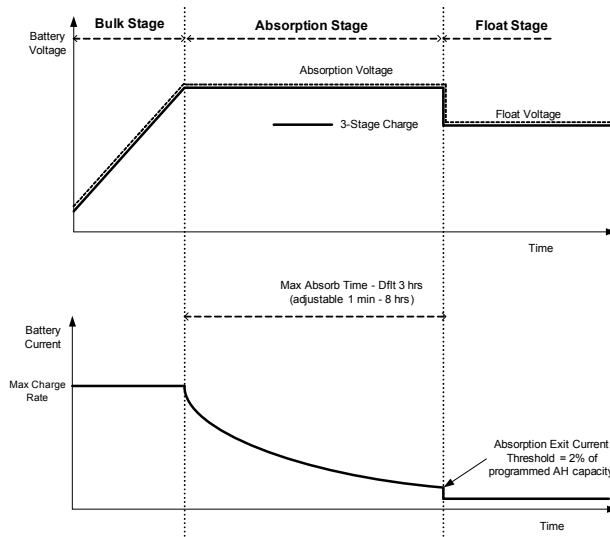

Figure 32 Three-Stage Battery Charging Cycle

NOTE:

When the charge cycle is interrupted, the charger will restart charging at the beginning of the multi-stage algorithm.

Exit Current Threshold can be effectively disabled by programming the amp-hour capacity to the minimum. In this case, absorption will only exit once the Max Absorption timer expires.

Charge current during equalize state (optional state not shown here) is normally limited to 10% of the programmed amp-hour capacity setting. If this setting is programmed to the maximum, the charge current during equalize is instead limited to whatever is programmed for the maximum current limit of the unit.

Synchronized charge states are active when more than one charging device is connected in the system via the Xanbus network.

- The first unit (Freedom SW) to enter bulk, causes all other chargers to enter bulk.
- The first Freedom SW to enter absorption causes all other Freedom SWs to enter absorption.
- The last Freedom SW ready to exit absorption triggers all Freedom SWs to exit absorption and exit charge.

Bulk Stage

Bulk charge is the first stage in the charging process and provides the batteries with a controlled, constant current. Once the battery voltage rises to the absorption voltage threshold, the charger switches to the absorption stage.

Battery Charging Reference

Absorption Stage

During the absorption stage, the Freedom SW begins operating in constant voltage mode and the current falls gradually as the amp hours are returned to the battery. By default, the bulk and absorption voltage settings are the same for all battery types. The voltage limit settings for bulk and absorption can be adjusted independently if the battery type is set to **Custom**.

Once the Freedom SW reaches the **Bulk (Absorption)**, after the first 60 minutes) **Voltage** setting, the Freedom SW will operate in constant voltage mode, providing only the necessary current to maintain the voltage setting. As the amp hours are returned to the battery, the current required to maintain the voltage setting falls gradually.

The Freedom SW transitions to the float stage if either one of the following two conditions are met:

1. The charge current allowed by the batteries falls below the exit current threshold, which is equal to 2% of the programmed battery capacity (for a 500 amp-hour battery bank, this would be 10 amps), for three minutes.
2. The Freedom SW has been in absorption for the programmed maximum absorption time limit. The default is 3 hours, but the time limit is programmable from 1 minute to 8 hours.

NOTE: If there are DC loads on the batteries, the charger's current may never decrease to a level to initiate the next stage of charging. In this case, the charger would stay in absorption until the **Absorb Time** setting is reached.

NOTE: To make sure the charger does not remain in absorption for too long, adjust **Absorb Time** on the **Charger Settings** menu. The timer begins at the start of the absorption stage and terminates absorption charging if the charge current does not decrease to below 2 per cent of the battery capacity before the **Absorb Time** setting expires. The **Absorb Time** setting may be increased if the charge cycle continually runs the full **Absorb Time** in the absence of DC loads. This is an indication of too large a battery bank for the selected **Absorb Time** setting.

Float Stage

Float charge maintains the batteries slightly above the self discharge voltage of the batteries. The charge current in float is the current necessary to maintain the batteries at the **Float Voltage** setting, limited only by the inverter's capability or other settings that limit the inverter's maximum charge rate. Float charging reduces battery gassing, minimizes watering requirements (for flooded batteries), and makes sure the batteries are in a constant state of readiness. When three-stage charging is selected, the charger automatically switches to the float stage after the batteries have received a bulk and absorption charge (see Figure 32). The batteries are maintained at the default float voltage level for the selected battery type or the voltage selected under **Float Voltage** on the **Custom Battery Settings** menu.

NOTE: The battery voltage can increase above the float voltage when using an external charging device such as PV arrays, wind turbines, and micro-hydro generators. Be sure to include appropriate charge management equipment with all external DC sources.

Battery Charging Reference

Two-Stage Charging Process

Two-stage (or no float) mode differs from an ordinary three-stage charge mode in that it does not continuously maintain the battery at float voltage. Instead, the Freedom SW begins charging the battery in bulk mode whenever the battery voltage drops below the recharge level. While the battery voltage is above the recharge level the inverter's AC transfer switch continues to pass power through from the utility grid to the loads, but does not actively charge the batteries.

Two-stage mode increases efficiency of utility connected systems by reducing the amount of power consumed by the inverter and batteries compared to when the battery is continuously maintained at **Float Voltage**. This feature can extend the life of most batteries.

NOTE: If the AC input fails or drops below the lower VAC limit (as set in **AC Settings**), the complete multi-stage charge cycle (bulk, absorption, float/no float) restarts once the source AC recovers to within the acceptable range. If the batteries are already nearly full, the charge cycle will take little time to complete.

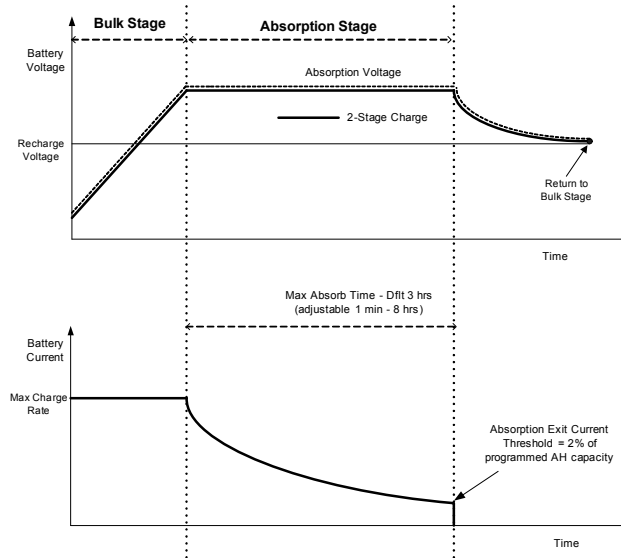

Figure 33 Two-Stage Charging Cycle

Battery Charging Reference

NOTE:

When the charge cycle is interrupted, the charger will restart charging at the beginning of the multi-stage algorithm.

Exit Current Threshold can be effectively disabled by programming the amp-hour capacity to the minimum. In this case, absorption will only exit once the **Max Absorption** timer expires.

Charge current during equalize state (optional state not shown here) is normally limited to 10% of the programmed amp-hour capacity setting. If this setting is programmed to the maximum, the charge current during equalize is instead limited to whatever is programmed for the max current limit of the unit.

Synchronized charge states are active when more than one charging device is connected in the system via the Xanbus network.

- The first unit to enter bulk, causes all other chargers to enter bulk.
 - The first Freedom SW to enter absorption causes all other Freedom SWs to enter absorption.
 - The last Freedom SW ready to exit absorption triggers all Freedom SWs to exit absorption and exit charge.
-

Battery Charging Reference

Equalize Charging

Many battery manufacturers recommend periodic equalize charging to counter cell charge imbalance and capacity-robbing electrolyte stratification. Equalizing helps to improve battery performance and lifespan by encouraging more of the battery material to become active.

Battery equalization is a controlled overcharging method that mixes up stratified electrolyte and reactivates unused areas of the plate material. Periodic equalizing can help to regularly restore batteries to a full and healthy state of charge.

Consult the battery manufacturer's recommendation for equalize charging settings. Sealed batteries should **never** be equalized. Consult the battery manufacturer for optimal charging procedures when using sealed batteries.

When **Equalize** mode is enabled, the battery is charged from bulk to absorption, and then to the equalize phase. The Freedom SW will transition from the absorption phase to equalize if:

- the DC charge current is below 2% of the configured battery capacity (for example, 8.8A for 440Ah).
- the absorption time is exceeded (for example, 180 min).

After absorption, the maximum charge DC current is set to 10% of battery capacity (for example, 44A for 440Ah). See Figure 34. This constant current charge will continue until the voltage has increased to the equalize voltage at which point the battery will be regulated at the temperature-compensated equalize voltage.

If the battery capacity is set to zero (Ah=0 effectively disables the exit current criteria for the absorption charge stage making the absorption stage defined by time only), the equalize charge current is fixed at maximum 100% of the charge rate.

Equalization duration is fixed at one hour.

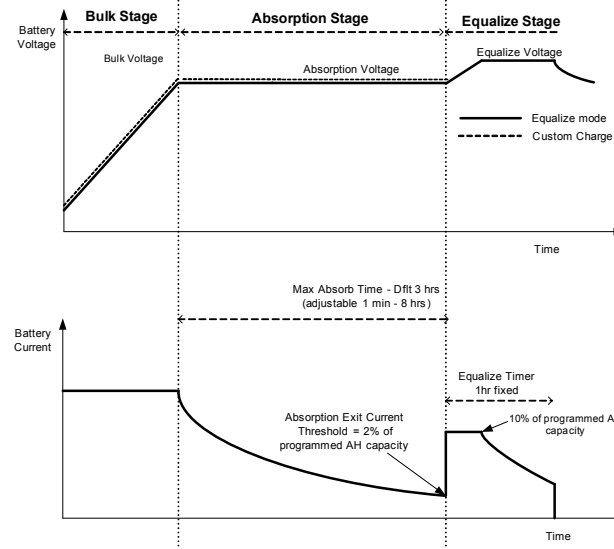
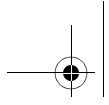
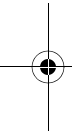

Figure 34 Equalize Charging



Battery Charging Reference



Troubleshooting

General Troubleshooting Guidelines

This section will help you narrow down the source of any problem you may encounter. Please read the following troubleshooting steps:

1. Check for a warning or fault message on the Xanbus SCP or a fault code on the inverter information panel. If a message is displayed, record it immediately.
2. As soon as possible, record the conditions at the time the problem occurred. These details should include the following information:
 - loads the Freedom SW was running or attempting to run
 - battery condition at the time of failure (battery voltage or temperature, for example), if known
 - recent sequence of events (for example, charging had just finished, utility grid had failed but the inverter did not come on)
 - any known unusual AC input factors such as low voltage or unstable generator output
 - extreme conditions which may have existed at the time (temperature or moisture, for example).
3. Attempt the solution indicated in these guidelines.
4. If your inverter information panel or Xanbus SCP is not displaying a Fault light, check the following list to make sure that the present state of the installation allows proper operation of the unit. Read these guidelines carefully.
 - Is the Freedom SW located in a clean, dry, adequately ventilated area?
 - Have the AC input breakers opened? If so, your pass-through load may have exceeded the rating of one or more of the input breakers.
 - Are the battery cables adequately sized and short enough? See the Installation Guide for more information.
 - Is the battery in good condition and are all DC connections tight?
 - Are the AC input and output connections and wiring in good condition?
 - Are the configuration settings correct for your particular installation?
 - Are the display panel and the communications cable properly connected and undamaged?
 - Is the battery temperature sensor and its cable properly connected and undamaged?
5. Contact Customer Service for further assistance. Please be prepared to describe details of your system installation and provide the model and serial number of the unit. See the front and/or back of the manual for contact information.

Troubleshooting

Inverter Applications

The Freedom SW performs differently depending on the AC loads connected to it. If you are having problems with any of your loads, read this section.

Resistive Loads

Resistive loads are the easiest and most efficient to drive. Voltage and current are in phase, which means they are in step with one another. Resistive loads generate heat in order to accomplish their tasks. Toasters, coffee pots, and incandescent lights are typical resistive loads. It is usually impractical to run larger resistive loads—such as electric stoves and water heaters—from an inverter due to their high current requirements. Even though the inverter may be able to accommodate the load, the size of battery bank will limit inverter run time.

Motor Loads

Induction motors (AC motors without brushes) require up to six times their running current on startup. The most demanding are those that start under load (for example, compressors and pumps). Of the capacitor start motors (typical in drill presses and band saws, for example), the largest you can expect to run is 1 horsepower. Universal motors are generally easier to start. Check that the Locked Rotor Amps (LRA) rating of the motor load does not exceed the maximum surge current rating of the inverter. Since motor characteristics vary, only testing will determine whether a specific load can be started and how long it can be run.

If a motor fails to start within a few seconds or loses power after running for a time, it should be turned off. When the inverter attempts to start a load that is greater than it can handle, the inverter may shut down from an AC overload fault.

Problem Loads

Very Small Loads If the power consumed by a device is less than the threshold of the search mode circuitry, and search mode is enabled, the inverter will not run. Most likely the solution will be to disable **Search** mode or lower the sense threshold.

Fluorescent Lights and Power Supplies Some devices cannot be detected when scanned by search mode circuitry. Small fluorescent lights are the most common example. Some computers and sophisticated electronics have power supplies that do not present a load until line voltage is available. When this occurs, each unit waits for the other to begin. To drive these loads, either a small companion load like a light bulb rated for more than the **Search Watts** setting must be used to bring the inverter out of search mode, or the inverter may be programmed to remain on by disabling **Search** mode. (See “Using Search Mode” on page 34.)

Clocks You may notice that your clocks are not accurate. Some of the clocks on your appliances may reset when the Freedom SW is in search mode.

Searching When the inverter is in search mode, it may fail to start some loads even though the rated wattage on the load is more than the **Search Watts** setting. Disable **Search** or apply an additional load (companion load) to make the inverter exit search mode.

Fault Types

There are three types of fault messages: automatic faults, manual faults, and escalating automatic faults. Table 3 describes how they differ in their behavior and how you can respond to them when they appear on the SCP.

Table 1 Fault Types And Behaviors

Fault type	Behavior
Automatic faults	Clear automatically if the fault condition that generated the message goes away. You can also acknowledge automatic faults without waiting for them to clear automatically.
Manual faults	Require you to clear them by: <ul style="list-style-type: none">• selecting Clear Faults on the Main Freedom SW menu or on the menu for the Xanbus-enabled device that generated the fault (if the fault condition still exists, the fault message reappears)• correcting the condition that caused the fault.
Escalating automatic faults	Clear automatically if the fault condition goes away, just like an automatic fault. However, if an escalating automatic fault occurs several times within a defined time period, the escalating automatic fault becomes a manual fault, requiring user intervention. For example, if an AC Overload fault occurs three times in five minutes, it will no longer clear itself and become a manual fault. Then you must identify the problem, correct the fault condition, and clear the fault.

Troubleshooting

Troubleshooting the Freedom SW via the SCP

The Freedom SW is designed with a number of protection features to provide efficient operation. If, however, you have any problems operating your inverter/charger read this troubleshooting chapter.

If you cannot resolve the problem, record the information about your system. This information will help your dealer or customer service to assist you better when you contact them.

DANGER

ELECTRICAL SHOCK HAZARD

Do not disassemble the inverter/charger. The Freedom SW contains no user-serviceable parts.

Failure to follow these instructions will result in death or serious injury.

When a fault or warning message appears, you can acknowledge the message to clear the screen. To acknowledge a fault or warning message, press the **Enter** button on the SCP. This action does not clear the fault or warning condition, so you should consult Table 4 for suggested actions after you have acknowledged the message. Refer to the *Xanbus System Control Panel Owner's Guide* for more information on faults and warnings.

Fault Types

There are three types of fault messages: automatic faults, manual faults, and escalating automatic faults. Table 2 describes how they differ in their behavior and how you can respond to them when they appear on the SCP.

Table 2 Faults Types and Behaviors

Fault type	Behavior
Automatic fault	Clears automatically if the condition that generated the message goes away. You can also acknowledge automatic faults without waiting for them to clear automatically.
Manual fault	Requires you to clear it by: <ul style="list-style-type: none"> selecting Clear Faults on the Freedom SW or on the device that generated the fault (if the condition still exists, the fault message reappears). correcting the condition that caused the fault.

Table 2 Faults Types and Behaviors

Fault type	Behavior
Escalating automatic faults	Clear automatically if the fault condition goes away, just like an automatic fault. However, if an escalating automatic fault occurs several times within a defined time period, the escalating automatic fault becomes a manual fault, requiring user intervention. For example, if three faults occur in one minute, it will no longer clear itself but becomes a manual fault. Then you must identify the problem, correct the fault condition, and clear the fault or reset the device.

To view a fault list:

1. On the Select Device menu, highlight System and press **Enter**.
2. On the System Settings menu, highlight View Fault List.
3. Press **Enter**.

Warning Types

There are two types of warnings: automatic and manual. When the Freedom SW detects a warning condition, it displays a warning message on the SCP.

Table 3 describes how they differ in their behavior and in how you can respond to them when they appear on the SCP.

Table 3 Warning Types and Behavior

Warning type	Behavior
Automatic warning	Clears automatically if the fault condition that generated the message goes away. You can also acknowledge automatic warnings without waiting for them to clear automatically.
Manual warning	Requires you to acknowledge it before you can proceed with configuring or operating the Freedom SW. Manual warnings are usually in the form of a Yes/No question that you may acknowledge by pressing the Enter button on the SCP for Yes and the Func button for No. Refer to the <i>Xanbus System Control Panel Owner's Guide</i> for more information.

To view a warning list:

1. On the Select Device menu, highlight System and press **Enter**.
2. On the System Settings menu, highlight View Warning List.
3. Press **Enter**.

Troubleshooting

Table 4 provides a detailed description of the fault messages and solutions. If you are unable to resolve the problem after referring to this table, contact your dealer or Customer Service.

Table 4 Fault Messages

Fault Number	Message	Fault Type	Cause	Solution
F1	AC Output under voltage	Escalating Auto Fault. Must occur 3 times in 30 seconds before becoming a manual fault.	Inverter voltage is under 100 volts.	Remove excessive load.
F2	AC Output over voltage	Escalating Auto Fault. Must occur 3 times in 30 seconds before becoming a manual fault.	Inverter voltage is over 135 volts.	Check if there is an external power source that is running parallel to the inverter's output.
F17	Relays Welded	Manual	AC backfeed from welded relay.	Service required.

Table 4 Fault Messages

Fault Number	Message	Fault Type	Cause	Solution
F44	Battery Over Temperature	Automatic	Battery temperature is over 140 °F (60 °C). Poor battery compartment ventilation.	Stop charging if necessary. Check cable connections. Check battery voltage/current and temperature. If battery is not accepting charge, it may need to be replaced. Check for excessive ambient temperature and adequate ventilation in the battery compartment.
		Automatic	BTS may be damaged.	If the unit displays a temperature of over 212 °F (100 °C), the BTS will need to be replaced.
F47	DC Under Voltage (Immediate)	Automatic	Immediate battery under voltage fault.	Check battery condition (short or open cells) and ensure correct voltage. Battery state charge or capacity is so low that the DC voltage collapses when inverter load is applied. Inverter load is so large that the DC voltage collapses when inverter load is applied.

Troubleshooting

Table 4 Fault Messages

Fault Number	Message	Fault Type	Cause	Solution
F48	DC Under Voltage (Fault)	Automatic	Voltage at the DC input terminals is below the Low Battery Cut Out (LBCO) setting for 10 seconds.	Check for the correct battery voltage at the inverter's DC input terminals. Check for external DC loads on the batteries. Check condition of batteries and recharge if necessary. Reduce the Low Battery Cut Out (LBCO) setting. Battery bank capacity may be inadequate for the loads in the system.
F49	DC Over Voltage	Automatic	Voltage at the DC input terminals is above the High Battery Cut Out Setting	Clear the fault and attempt restart. Ensure battery voltage is 10–16 VDC at Freedom SW terminals. Check all other charging source outputs, battery cables.

Table 4 Fault Messages

Fault Number	Message	Fault Type	Cause	Solution
F57	FET1 Over Temperature	Automatic	Ambient temperature may be too high.	Ensure adequate ventilation around the Freedom SW. Allow inverter to cool down and try restarting.
			Operating too large of a load for too long while inverting.	Remove excessive inverter loads.
			Inverter cooling fan may have failed.	If the temperature is above 104 °F (40 °C), the fan should be on. Hold your hand or a piece of paper to the inverter vent to check if the fan is working. Both fans should be active at the same time.
			Inverter airflow intake may be blocked.	Increase the clearance around the inverter and/or unclog the airflow intake vents.
F58	FET2 Over Temperature	Automatic	Same as F57.	Same as F57.
F63	Power Board Temp unreadable.	Automatic	Temperature sensor is damaged.	Service required.

Troubleshooting

Table 4 Fault Messages

Fault Number	Message	Fault Type	Cause	Solution
F64	AC overload	Escalating Auto Fault. Must occur 3 times in 60 seconds before becoming a manual fault.	Persistent excessive inverter current above rated current.	Avoid loads with long surge current.
F68	Transformer Over Temperature	Automatic	Same as F57.	Same as F57.
F69	External Sync Failed	Automatic	When Series stacking—the Stacking cable is not installed.	Install the Stacking cable to connect the two inverter/chargers.
F70	Unique Dev# Needed	Automatic	When stacking (Series or Parallel)—if two units have the same Device Number.	Change the Device Number of one unit. See “Setting the Device Number” on page 56.
F71	Too Many Masters	Automatic	When stacking (Series or Parallel)—if two units are configured as Master units.	Change one unit to a Slave unit. See Stack Mode under “Stacking Configuration Menu” on page 54 in Table 17.
F73	Transformer Temp unreadable	Automatic	Temperature sensor is damaged.	Service required.
F74	Other Unit Invert Fault	Automatic	When stacking (Series or Parallel)—if one of the units encounters a fault that needs to be resolved.	Clear the primary fault on the unit that caused this fault.

Table 4 Fault Messages

Fault Number	Message	Fault Type	Cause	Solution
F75	Master Inverter Lost	Automatic	When Parallel stacking—if the Slave unit cannot detect the Master unit in the Xanbus network.	Make sure that the two units are connected in the same Xanbus network. Check cable connections and ensure that the plugs are neatly inserted in the ports. Check if the Xanbus network is properly installed with network terminators.
F85	PowerBoard Over Temperature	Automatic	Same as F57.	Same as F57.

Troubleshooting

Table 5 provides a detailed description of the warning messages and solutions. If you are unable to resolve the problem after referring to this table, contact your dealer or Customer Service.

Table 5 Warning Messages

Fault Number	Message	Fault Type	Cause	Solution
W48	DC under voltage (Warning)	Automatic	Voltage at the DC input terminals is below the Low Battery Cut Out (LBCO) setting.	Check for the correct battery voltage at the inverter's DC input terminals. Check for external DC loads on the batteries. Check condition of batteries and recharge if necessary. Reduce the Low Battery Cut Out (LBCO) setting. Battery bank capacity may be inadequate for the loads in the system.
W69	AGS not connected	Automatic	The GenSup Mode setting is enabled but there is no AGS connected in the Xanbus network.	Install a Xanbus AGS on the network or disable the GenSup Mode setting.

Specifications

NOTE: Specifications are subject to change without prior notice.

Physical Specifications	Freedom SW 2012	Freedom SW 2024	Freedom SW 3012	Freedom SW 3024
L × W × H	387×343×197 mm (15.25×13.5×7.75 in.)			
Net Weight	27.5 kg (60.5 lbs)		31.5 kg (69.4 lbs)	

Environmental Specifications	Freedom SW 2012	Freedom SW 2024	Freedom SW 3012	Freedom SW 3024
Nominal Ambient temperature	30 °C (86 °F)		40 °C (104 °F)	
Invert mode:				
• Operating range (full power)	-20 to 30 °C (-4 to 86 °F)		-20 to 40 °C (-4 to 104 °F)	
• Load @ maximum ambient	1700W @ 60 °C		2600W @ 60 °C	
Charge mode:				
• Operating range (full power)	-4 to 104 °F (-20 to 40 °C)	-4 to 104 °F (-20 to 40 °C)	-4 to 77 °F (-20 to 25 °C)	-4 to 104 °F (-20 to 40 °C)
• Current @ maximum ambient	80 A @ 140 °F (60 °C)	40 A @ 140 °F (60 °C)	120 A @ 140 °F (60 °C)	60 A @ 140 °F (60 °C)
Storage temperature range	-67 to 167 °F (-55 to 75 °C)		-40 to 185 °F (-40 to 85 °C)	
Humidity: Operation/Storage	≤ 95% RH, non-condensing			
Altitude:				
• Operating	4,572 m (15,000 feet)			
• Non-operating	15,240 m (50,000 feet)			
Mounting	deck mount, wall mount with fans and DC/AC sides facing sideward			

Specifications

NOTE: All inverter specifications are at nominal conditions: 12 (or 24) volts DC inverting 120 volts AC, unless otherwise specified.

Inverter Specifications	Freedom SW 2012	Freedom SW 2024	Freedom SW 3012	Freedom SW 3024
Output wave form	pure sine wave (true sine wave)			
Output power (continuous)	2000 W (up to 30 °C)		3000 W (up to 40 °C)	
Output power (5 seconds)	4000 W		6000 W	
Output current	17 A		24 A	
Peak output current	55 A		80 A	
Output frequency	60 Hz ± 0.2 Hz		60 Hz ± 0.2 Hz	
Output voltage	120 VAC		120 VAC	
AC output connection/s	Single		Split phase in/dual out, Dual in/dual out	
Peak efficiency	90%	94%	90%	94%
No-load current draw (Inverter On)	<3 ADC	<1.5 ADC	<3 ADC	<1.5 ADC
Standby current draw (Inverter Off)	<0.25 ADC	<0.15 ADC	<0.25 ADC	<0.15 ADC
Input DC voltage range	10–16 VDC	20–32 VDC	10–16 VDC	20–32 VDC
Low battery voltage shutdown cut-off	10.5 V (selectable)	21.0 V (selectable)	10.5 V (selectable)	21.0 V (selectable)
High battery voltage shutdown cut-off	16.5 V (selectable)	33.0 V (selectable)	16.5 V (selectable)	33.0 V (selectable)

Specifications

NOTE: All charging specifications are at nominal conditions: ambient temperature of 77 °F (25 °C), 120 VAC, 60 Hz input, unless otherwise specified.

Charger Specifications	Freedom SW 2012	Freedom SW 2024	Freedom SW 3012	Freedom SW 3024
Charging method	Three-stage charge (Bulk, Absorption, Float) Two-stage charge (Bulk, Absorption) The default charging method is three-stage.			
Without a battery temperature sensor	Three settings with the following temperature values: Cool 50 °F (10 °C) Warm 77 °F (25 °C) Hot 104 °F (40 °C) The default setting is Warm and it can only be changed by the factory, a dealer, or a service centre.			
With a battery temperature sensor (included)	The temperature compensation coefficients on a 12-volt battery are as follows: Flooded: 27 mV × (25 °C – BTS °C) Gel: 27 mV × (25 °C – BTS °C) AGM: 21 mV × (25 °C – BTS °C)		The temperature compensation coefficients on a 24-volt battery are as follows: Flooded: 54 mV × (25 °C – BTS °C) Gel: 54 mV × (25 °C – BTS °C) AGM: 42 mV × (25 °C – BTS °C)	
Output current (maximum)	100 ADC	50 ADC	150 ADC	75 ADC
Output voltage	12 VDC	24 VDC	12 VDC	24 VDC
Output voltage range	3.0–16.0 VDC	3.0–32.0 VDC	3.0–16.0 VDC	3.0–32.0 VDC
Equalization cycle	Automatic, Manual by Xanbus SCP		Automatic, Manual by Xanbus SCP	
Optimal charging efficiency	> 85%		> 85%	
AC input power factor (at full charge rate)	> 0.98		> 0.95	
AC input current	24A max. (including pass-thru)		24A max. (including pass-thru)	
AC input voltage	120 VAC		120 VAC	
AC input voltage range	85–140 VAC		85–140 VAC	
Dead battery charge voltage	> 5.0 VDC	> 12.0 VDC	> 5.0 VDC	> 12.0 VDC
Supported AC input types	Single input (up to 30 amps)		Split phase (up to 30 amps per line) Dual input (up to 30 amps per line)	

Specifications

NOTE: All transfer specifications are at nominal conditions: ambient temperature of 77 °F (25 °C), 120 VAC, 60 Hz input, unless otherwise specified.

Transfer and General Specifications

All Models

Transfer time—utility to invert	< 20 ms
Minimum AC input voltage for transfer	85 VAC
Maximum AC input voltage for transfer	135 VAC
Minimum AC input frequency for transfer	45 Hz
Maximum AC input frequency for transfer	70 Hz
Cooling	Fan-cooled, temperature controlled.

Regulatory Approvals

All Models

Safety	CSA 107.1, UL 458 5th Ed. with marine supplement, ABYC E11 - Alternating Current and Direct Current Electrical Systems on Boats, and ABYC A31 - Battery Chargers and Inverters.
EMC	FCC Part 15, Class B Industry Canada ICES-0003, Class B

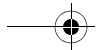
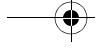

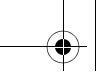

**Schneider Electric Solar
Inverters USA Inc.**

1 800 670 0707 Tel toll free
1 408 987 6030 Direct
1 800 994 7828 Fax toll free
www.xantrex.com



97-0019-01-01

Printed in China.

